

Cytation™ 5

Cell Imaging Multi-Mode Reader

Instructions for Use



BioTek® Instruments, Inc.

January 2015

© 2015

PN 1321022

Revision A

Notices

BioTek® Instruments, Inc.
Highland Park, P.O. Box 998
Winooski, Vermont 05404-0998 USA

All Rights Reserved

© 2015, BioTek® Instruments, Incorporated. No part of this publication may be reproduced, transcribed, or transmitted in any form, or by any means electronic or mechanical, including photocopying and recording, for any purpose other than the purchaser's use without written permission of BioTek Instruments, Inc.

Trademarks

BioTek® is a registered trademark, and Cytation™, Gen5™, BioStack™, and Take3™ are trademarks of BioTek Instruments, Inc. Glowell™ is a trademark of LUX Biotechnology, Ltd. Harta™ is a trademark of Harta Instruments.

Microsoft®, Windows®, and Excel® are either registered trademarks or trademarks of Microsoft Corporation in the United States and/or other countries.

All other trademarks are the property of their respective holders.

Restrictions and Liabilities

Information in this document is subject to change and does not represent a commitment by BioTek Instruments, Inc. Changes made to the information in this document will be incorporated in new editions of the publication. No responsibility is assumed by BioTek for the use or reliability of software or equipment that is not supplied by BioTek or its affiliated dealers.

Contact Information

Customer Service and Sales

Internet: www.biotek.com
 Phone: 888-451-5171 (toll-free in the U.S.)
 802-655-4740 (outside the U.S.)
 Fax: 802-655-7941
 Email: customercare@biotek.com

Global Service and Support

BioTek instrument service and repair is available worldwide at one of BioTek's International Service Centers and in the field at your location. For technical assistance, contact the Technical Assistance Center (TAC) at BioTek US—World Headquarters. To arrange for service or repair of your instrument, contact the office nearest you.

<p>BioTek US—World Headquarters</p> <p>Phone: (802)655-4740 Toll-Free: (888)451-5171 Service Toll-Free: (800)242-4685 Email: CustomerCare@biotek.com Service Email: TAC@biotek.com www.biotek.com</p>	<p>BioTek China—Beijing</p> <p>Phone: +86 (10) 85865569 Email: infochina@biotek.com Website: www.biotekchina.com.cn</p>
<p>BioTek China—Shanghai</p> <p>Phone: +86 (021)50435800 Email: infochina@biotek.com Website: www.biotekchina.com.cn</p>	<p>BioTek France</p> <p>Phone: +33 (3) 89206329 Email: info@biotek.fr Website: www.biotek.fr</p>
<p>BioTek Germany—European Coordination Center</p> <p>Phone: +49 (0) 71369680 Email: info@biotek.de Website: www.biotek.de</p>	<p>BioTek India</p> <p>Phone: +91 (22) 66870046 Fax: +91 (22) 28759944 Email: biotek@biotek.in Website: www.biotek.in</p>
<p>BioTek Japan</p> <p>Phone: +81(0)3 5812 8109 Email: infojapan@biotek.com Website: www.biotek.com/ja</p>	<p>BioTek Singapore</p> <p>Phone: +65 65922100 Email: singapore@biotek.com Website: www.biotek.com</p>

<p>BioTek South Korea</p> <p>Phone: +82 (0) 2 5624740 Email: korea@biotek.com Website: www.biotekinstruments.co.kr</p>	<p>BioTek Switzerland</p> <p>Phone: +41 (41) 2504060 Email: info@biotek.ch Website: www.biotek.ch</p>
<p>BioTek Taiwan</p> <p>Phone: +886(2)26277725 Email: infotaiwan@biotek.com Website: www.biotek.com</p>	<p>BioTek United Kingdom (UK)</p> <p>Email: CustomerCare@biotek.com Website: www.biotek.uk.com</p>

Instructions for Use Requirements

This document fulfills the basic needs of persons operating this device, according to the requirements of the In Vitro Diagnostic Directive for "Instructions for Use." Some of the device's higher-level functions and features, as well as certain detailed maintenance and qualification routines, are described in the *Cytation 5 Operator's Manual*.

Intended Use Statement

The Cytation 5 is a hybrid multi-mode microplate reader. The performance characteristics of the data reduction software have not been established with any laboratory diagnostic assay. The user must evaluate this instrument and PC-based software in conjunction with their specific assay(s). This evaluation must include the confirmation that performance characteristics for the specific assay(s) are met.

- If the instrument has an "IVD" label, it may be used for clinical and non-clinical purposes, including research and development. If there is no such label, the instrument may be used only for research and development or other non-clinical purposes.

Quality Control

It is considered good laboratory practice to run laboratory samples according to instructions and specific recommendations included in the assay package insert for the test to be conducted. Failure to conduct Quality Control checks could result in erroneous test data.

Warnings



Operate the instrument on a level, stable surface away from excessive humidity.

Bright sunlight or strong incandescent light can reduce the linear performance range of the instrument.

Measurement values may be affected by extraneous particles (such as dust) in the microplate wells. A clean work area is necessary to ensure accurate readings.

When operated in a safe environment according to the instructions in this document, there are no known hazards associated with the instrument. However, the operator should be aware of certain situations that could result in serious injury; these may vary depending on the instrument model. See **Hazards and Precautions**.

Hazards

The following hazards are provided to help avoid injury:



Warning! Power Rating. The instrument's power supply or power cord must be connected to a power receptacle that provides voltage and current within the specified rating for the system. Use of an incompatible power receptacle may produce electrical shock and fire hazards.

Warning! Electrical Grounding. Never use a plug adapter to connect primary power to the external power supply. Use of an adapter disconnects the utility ground, creating a severe shock hazard. Always connect the power cord directly to an appropriate receptacle with a functional ground.

Warning! Service. Only qualified technical personnel should perform service procedures on internal components.

Warning! Accessories. Only accessories that meet the manufacturer's specifications shall be used with the instrument.

Warning! Lubricants. Do not apply lubricants to the microplate carrier or carrier track. Lubricant on the carrier mechanism or components in the carrier compartment will attract dust and other particles, which may obstruct the carrier path and cause the instrument to produce an error.

Warning! The instrument with all available modules weighs up to **80 lbs. (36.3 kg)**. Use two people when lifting and carrying the instrument.

Warning! Liquids. Avoid spilling liquids on the instrument; fluid seepage into internal components creates a potential for shock hazard. If a spill occurs while a program is running, abort the program and turn off the instrument. Wipe up all spills immediately. Do not operate the instrument if internal components have been exposed to fluid. Contact BioTek TAC for assistance.

Warning! Unspecified Use. Failure to operate the equipment according to the guidelines and safeguards specified in this manual could result in a hazardous condition.

Warning! Software Quality Control. The operator must follow the manufacturer's assay package insert when modifying software parameters and establishing reading methods. Failure to conduct quality control checks could result in erroneous test data.

Warning! Reader Data Reduction Protocol. No limits are applied to the raw measurement data. All information exported via computer control must be thoroughly analyzed by the operator.



Warning! Internal Voltage. Always turn off the power switch and unplug the power supply before cleaning the outer surface of the instrument or removing its top case.



Warning! Potential Biohazards. Some assays or specimens may pose a biohazard. This hazard is noted by the symbol shown here. Adequate safety precautions should be taken as outlined in the assay's package insert. Always wear safety glasses and appropriate protective equipment, such as chemical-resistant rubber gloves and apron.



Warning! LED Lights. Serious eye injury may occur if you stare directly at the LED during operation of the light. This hazard is noted by the symbol shown here.



Warning! Pinch Hazard. Some areas of the dispense module can present pinch hazards when the instrument is operating. The module is marked with the symbol shown here. Keep hands/fingers clear of these areas when the instrument is operating.

Precautions

The following precautions are provided to help avoid damage to the instrument:



Caution: Service. The instrument should be serviced by BioTek-authorized service personnel. Only qualified technical personnel should perform service procedures on internal components.

Caution: Spare Parts. Only approved spare parts should be used for maintenance. The use of unapproved spare parts and accessories may result in a loss of warranty and potentially impair instrument performance or cause damage to the instrument.

Caution: Environmental Conditions. Do not expose the system to temperature extremes. For proper operation, ambient temperatures should remain within the range listed in the **Specifications** chapter. Performance may be adversely affected if temperatures fluctuate above or below this range. Storage temperature limits are broader.

Caution: Sodium Hypochlorite. Do not expose any part of the instrument to the recommended diluted sodium hypochlorite solution (bleach) for more than 20 minutes. Prolonged contact may damage the instrument surfaces. Be certain to rinse and thoroughly wipe all surfaces.

Caution: Power Supply. Use only the power supply shipped with the instrument. Operate this power supply within the range of line voltages listed on it.

Caution: Disposal. Dispose of the instrument according to Directive 2012/19/EC, "on waste electrical and electronic equipment (WEEE)" or local ordinances.

Caution: Warranty. Failure to follow preventive maintenance protocols may void the warranty. See the **Maintenance** chapter.

Caution: Shipping Hardware. The shipping brackets must be removed before operating the instrument. They must be reinstalled before shipping the instrument. See the **Installation** chapter.

Caution: Electromagnetic Environment. Per IEC 61326-2-6 it is the user's responsibility to ensure that a compatible electromagnetic environment for this instrument is provided and maintained in order that the device will perform as intended.

Caution: Electromagnetic Compatibility. Do not use this device in close proximity to sources of strong electromagnetic radiation (e.g., unshielded intentional RF sources), because these may interfere with the proper operation.

CE Mark



Based on the testing described below and information contained herein, this instrument bears the CE mark

Refer to the Declaration of Conformity for specific details.

Directive 2014/30/EU: Electromagnetic Compatibility

Emissions—Class A

The system has been type-tested by an independent, accredited testing laboratory and found to meet the requirements of EN 61326-1: Class A for Radiated Emissions and Line Conducted Emissions.

Verification of compliance was conducted to the limits and methods of EN 55011 – (CISPR 11) Class A. In a domestic environment it may cause radio interference, in which case you may need to mitigate the interference.

Immunity

The system has been type-tested by an independent, accredited testing laboratory and found to meet the requirements of EN 61326-1 and EN 61326-2-6 for Immunity. Verification of compliance was conducted to the limits and methods of the following:

- EN 61000-4-2, Electrostatic Discharge
- EN 61000-4-3, Radiated EM Fields
- EN 61000-4-4, Electrical Fast Transient/Burst
- EN 61000-4-5, Surge Immunity
- EN 61000-4-6, Conducted Disturbances from RFI
- EN 61000-4-8, Power Frequency Magnetic Field Immunity Test
- EN 61000-4-11, Voltage Dips, Short Interruptions and Variations

Directive 2014/35/EU Low Voltage (Safety)

The system has been type-tested by an independent testing laboratory and was found to meet the requirements of this Directive. Verification of compliance was conducted to the limits and methods of the following:

- EN 61010-1. "Safety requirement for electrical equipment for measurement, control and laboratory use. Part 1, General requirements."
- EN 61010-2-081. "Particular requirements for automatic and semi-automatic laboratory equipment for analysis and other purposes."
- EN 61010-2-010. "Particular requirements for laboratory equipment for the heating of materials."

EN 60825-1, "Safety of laser products. Part 1: Equipment classification and requirements."

Directive 2012/19/EU: Waste Electrical and Electronic Equipment

Disposal Notice: Dispose of the instrument according to Directive 2002/96/EC, "on waste electrical and electronic equipment (WEEE)" or local ordinances.

Directive 98/79/EC: In Vitro Diagnostics (if labeled for this use)

- Product registration with competent authorities
- EN 61010-2-101. "Particular requirements for in vitro diagnostic (IVD) medical equipment."
- Traceability to the U.S. National Institute of Standards and Technology (NIST).

Electromagnetic Interference and Susceptibility

USA FCC CLASS A

RADIO AND TELEVISION INTERFERENCE

NOTE: This equipment has been tested and found to comply with the limits for a Class A digital device, pursuant to Part 15 of the FCC Rules. These limits are designed to provide reasonable protection against harmful interference when the equipment is operated in a commercial environment. This equipment generates, uses, and can radiate radio frequency energy and, if not installed and used in accordance with the instruction manual, may cause harmful interference to radio communications. Operation of this equipment in a residential area is likely to cause harmful interference, in which case the user will be required to correct the interference at their own expense.

In order to maintain compliance with FCC regulations, shielded cables must be used with this equipment. Operation with non-approved equipment or unshielded cables is likely to result in interference to radio and television reception.

Canadian Department of Communications Class A

This digital apparatus does not exceed Class A limits for radio emissions from digital apparatus set out in the Radio Interference Regulations of the Canadian Department of Communications.

Le présent appareil numérique n'émet pas de bruits radioélectriques dépassant les limites applicables aux appareils numériques de la Class A prescrites dans le Règlement sur le brouillage radioélectrique édicté par le ministère des Communications du Canada.













User Safety







This device has been type-tested by an independent laboratory and found to meet the requirements of the following:

- Underwriters Laboratories UL 61010-1, "Safety requirements for electrical equipment for measurement, control and laboratory use; Part 1: General requirements."
- Canadian Standards Association CAN/CSA C22.2 No. 61010-1, "Safety requirements for electrical equipment for measurement, control and laboratory use; Part 1: General requirements."
- EN 61010 Standards, see **CE Mark** starting on page viii.

Safety Symbols

Some of the following symbols may appear on the instrument or accessories:

 <p>Alternating current Courant alternatif Wechselstrom Corriente alterna Corrente alternata</p>	 <p>Warning, risk of crushing or pinching Attention, risque d'écrasement et pincement</p>
 <p>Warnen, Gefahr des Zerquetschens und Klemmen Precaución, riesgo del machacamiento y sejeción Attenzione, rischio di schiacciare ed intrappolarsi</p>	
 <p>Direct current Courant continu Gleichstrom Corriente continua Corrente continua</p>	 <p>Warning, hot surface Attention, surface chaude Vorsicht, heiße Oberfläche Precaución, superficie caliente Attenzione, superfice calda</p>
 <p>Both direct and alternating current Courant continu et courant alternatif Gleich - und Wechselstrom Corriente continua y corriente alterna Corrente continua e corrente alternata</p>	 <p>Laser radiation: Do not stare into beam Rayonnement laser: Ne pas regarder dans le faisceau</p>
	 <p>Laserstrahlung: nicht in den strahl blicken Radiación de laser: No mire fijamente al rayo Radiazione di laser: Non stare nel fascio</p>
 <p>Earth ground terminal Borne de terre Erde (Betriebserde) Borne de tierra Terra (di funzionamento)</p>	 <p>Warning, potential biohazards Attention, risques biologiques potentiels Warnung! Moegliche biologische Giftsoffe Atención, riesgos biológicos Attenzioni, rischio biologico</p>
 <p>Protective conductor terminal Borne de terre de protection Schutzleiteranschluss Borne de tierra de protección Terra di protezione</p>	 <p>Caution (refer to accompanying documents) Attention (voir documents d'accompagnement) Achtung siehe Begleitpapiere Atención (vease los documentos incluidos) Attenzione, consultare la doc annessa</p>

	On (Supply) Marche (alimentation) Ein (Verbindung mit dem Netz) Conectado Chiuso		Consult instructions for use Consulter la notice d'emploi Gebrauchsanweisung beachten Consultar las instrucciones de uso Consultare le istruzioni per uso
	Off (Supply) Arrêt (alimentation) Aus (Trennung vom Netz) Desconectado Aperto (sconnessione dalla rete di alimentazione)		In vitro diagnostic medical device Dispositif médical de diagnostic in vitro Medizinisches In-Vitro Diagnostikum Dispositivo médico de diagnóstico in vitro Dispositivo medico diagnostico in vitro
	Warning, risk of electric shock Attention, risque de choc électrique Gefährliche elektrische schlag Precaución, riesgo de sacudida eléctrica Attenzione, rischio di scossa elettrica		Separate collection for electrical and electronic equipment Les équipements électriques et électroniques font l'objet d'une collecte sélective Getrennte Sammlung von Elektro- und Elektronikgeräten Recogida selectiva de aparatos eléctricos y electrónicos Raccolta separata delle apparecchiature elettriche ed elettroniche

Installation

Package Contents

Item	Part #
<i>Cytation 5 Operator's Manual</i> (delivered on USB flash drive)	1321000
Power cord set (specific to installation environment):	
Europe (Schuko)	75010
USA/International	75011
United Kingdom	75012
Australia/New Zealand	75013
USB cable	75108
#2 Phillips screwdriver	01188
9/64" hex wrench	01623
<i>Models with the imaging module:</i>	
FireWire desktop interface	01604
OR	
FireWire laptop card and power supply	1220535 Power supply only: 01062
FireWire cable	1220538
Microplate slide holder	1220548
Isolation table	1220521
Objective adapter collar wrench	1222187
Objective setup plate	1222531
3/32" hex wrench	48570
<i>Models with an external dispense module (packed separately), with the following accessories:</i>	
Injector	8040541
Inlet tubes (2) from supply bottles to syringe drives	7082121
250- μ L syringes (2)	7083000

Item	Part #
Syringe thumbscrews	19511
Priming plate	8042202
Injector tip priming trough	8042068
Dispense module communication cable	75107
Dispense module front cover	8042197
Dispense module box	8040534
Supply bottles (2, 30 mL)	7122609
Supply bottle holders (2)	8042193
Injector tip cleaning stylus and plastic storage bag	2872304
Strap reagent racks (6)	7212035
<i>Models with the gas controller ("G" models)(packed separately):</i>	
Gas controller unit, CO ₂ /O ₂ control	1210500
Shipping accessories, CO ₂ /O ₂ control	1210010
Gas Controller Unit, CO ₂ only	1210504
Shipping accessories, CO ₂ only	1210009

1: Unpack and Inspect the Reader



The Cytation 5 should be removed from the box by two people. The instrument with all available modules weighs up to **80 pounds (36.6 kg)**.

Save all packaging materials. If you need to ship the reader to BioTek for repair or replacement, you must use the original materials. Using other forms of commercially available packaging, or failing to follow the repackaging instructions, may **void your warranty**.

During the unpacking process, inspect the packaging, reader, and accessories for shipping damage. If the reader is damaged, notify the carrier and your BioTek representative. Keep the shipping boxes and the packaging materials for the carrier's inspection. BioTek will arrange for repair or replacement immediately.

1. Open the shipping box, remove the instrument from the box, and place it on a level, stable surface.
2. Place the packaging materials back into the shipping box for reuse if the instrument needs to be shipped again.
3. *For the instruments with the imaging module:* Open the accessories box, and remove the isolation table.

2: Unpack and Inspect the Dispenser

If applicable:

1. Open the shipping box. Remove the accessories box and foam insert that contains the injector tubing and bottle holders.
2. Lift out the dispenser and place it on a level surface.
3. Open the accessories box and remove its contents.
4. Place all packaging materials into the shipping box for reuse if the dispenser needs to be shipped.

3: Unpack and Inspect the Gas Controller

If applicable:

1. Open the shipping box. Remove the accessories, and set them aside.
2. Lift out the gas controller, and place it on a level surface.
3. Place all packaging materials into the shipping box for reuse if the gas controller needs to be shipped.

4: Select an Appropriate Location

Install the reader on a level, stable surface in an area where ambient temperatures between 18°C (64°F) and 30°C (86°F) can be maintained.

Leave at least six inches of space between the instrument's rear panel and any other object. This space ensures proper air flow in and out of the instrument.

The reader is sensitive to extreme environmental conditions. Avoid the following:

- **Excessive humidity.** Condensation directly on the sensitive electronic circuits can cause the instrument to fail internal self-checks. The humidity must be in the range of 10–85%, non-condensing.
- **Excessive ambient light.** Bright light may affect the reader's optics and readings, reducing its linear range.
- **Dust.** Readings may be affected by extraneous particles (such as dust) in the microplate wells. A clean work area is necessary to ensure accurate readings.
- **Vibration.** The instrument should be installed in a vibration-free environment. Be sure to position the instrument away from other devices that could potentially create vibration during the read process.

If you are installing a BioStack for operation with the Cytation 5, you may wish to seat the instruments in their alignment plates now. Refer to the stacker's operator's manual for more information.

Installing Instruments with the Isolation Table

Cytation 5 models with the imaging module can be used with an isolation table, which helps to eliminate vibration during image reads.



Do not use the isolation table when operating the Cytation 5 with a microplate stacker. Store the isolation table in a clean, dry location.

1. Remove the four corner clips from the isolation table.

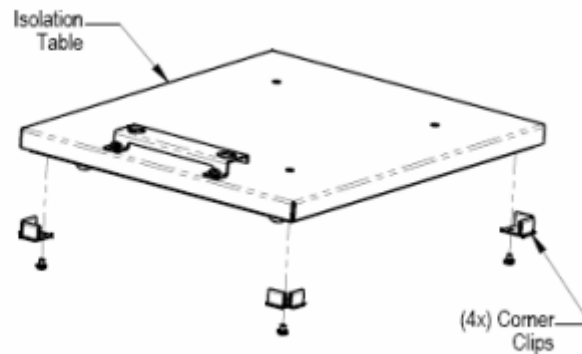

2. Place the isolation table in the selected installation location.
3. Place the instrument on the table as shown next:

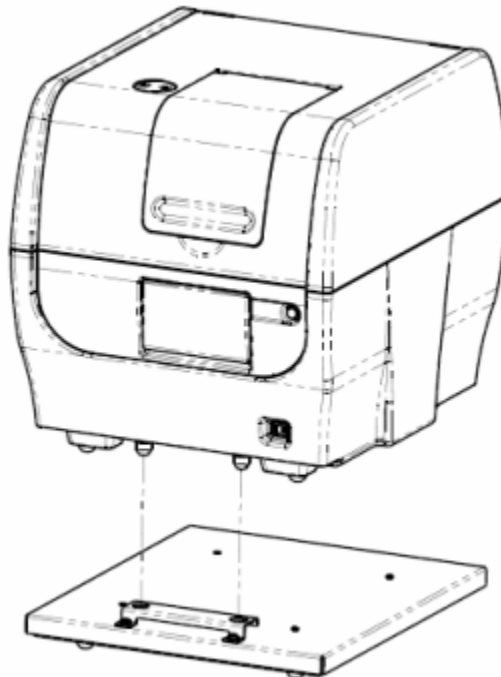

The isolation table contains material that dampens vibration. Over time, this material becomes compressed and can lose effectiveness. The isolation table has a color indicator that turns from green to red to show when the table should be replaced because the dampening material has been compressed.

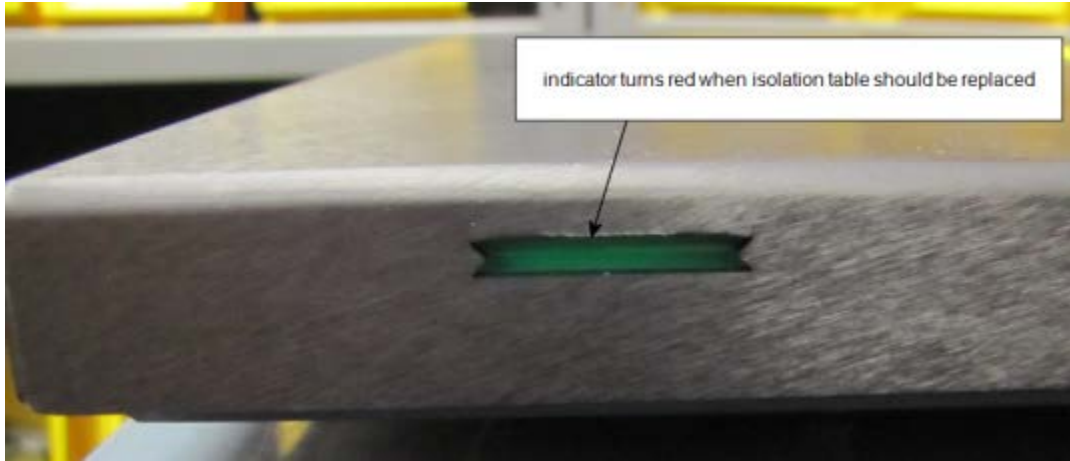

5: Remove the Shipping Hardware



Remove all shipping hardware before you turn on the reader.

1. Locate the shipping hardware.

The figures below depict a Cytation 5 with the filter module and imaging module.

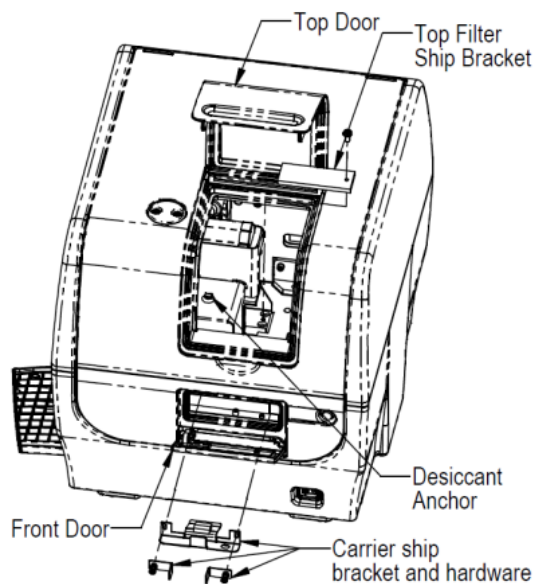

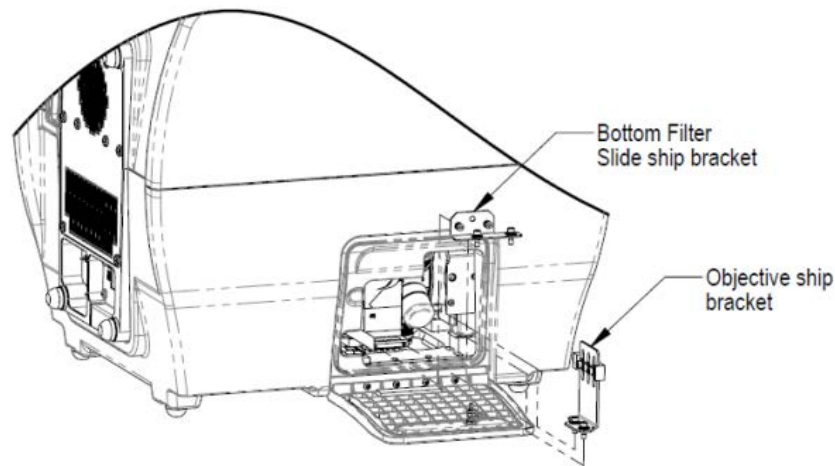

2. Open the top door, and remove the reusable zip tie and desiccant packet from the desiccant anchor.
3. If equipped, use the supplied screwdriver to remove the top filter shipping bracket.
4. Open the front door, and using the supplied screwdriver, remove the carrier shipping bracket.
5. If equipped with the imaging module, use a 9/64" hex wrench to remove the bottom filter slide ship bracket
6. Push the filter slide back, and remove the two-piece objective ship bracket.
7. Store the shipping hardware in a safe location, in case the instrument needs to be shipped again.

6: Install the Power Supply



Power Rating. The instrument must be connected to a power receptacle that provides voltage and current within the specified rating for the system. Use of an incompatible power receptacle may produce electrical shock and fire hazards.

Electrical Grounding. Never use a plug adapter to connect primary power to the instrument. Use of an adapter disconnects the utility ground, creating a severe shock hazard. Always connect the system power cord directly to an appropriate receptacle with a functional ground.

1. Locate the power inlet on the back of the reader.
2. Examine the power supply's plug. It has a small groove that lines up with a tab inside the power inlet.
3. Insert the plug into the power inlet and plug the power supply's cord into an appropriate power receptacle.

Do **not** plug the power supply into a power receptacle until after the power supply is connected to the instrument.

7: Install the Gas Controller (if applicable)

The gas controller is an external module that enables the user to control CO₂ and O₂ concentrations inside the attached instrument's reading chamber. If you purchased the module for operation with the Cytation 5, refer to the *Gas Controller User Guide* for installation instructions.

8: Unpack and Install the Joystick (if applicable)

If applicable:

1. Open the shipping box, lift out the joystick, and place it on a level surface.
2. Place all packaging materials into the shipping box for reuse if the joystick needs to be shipped.
3. Locate the joystick cable. Plug one end into the port on the back of the joystick. Plug the other end into the joystick port on the rear of the reader.

9: Install the Dispenser

Place the dispense module on top of the reader or on top of the gas controller (if equipped). Do not place the dispenser next to the reader.

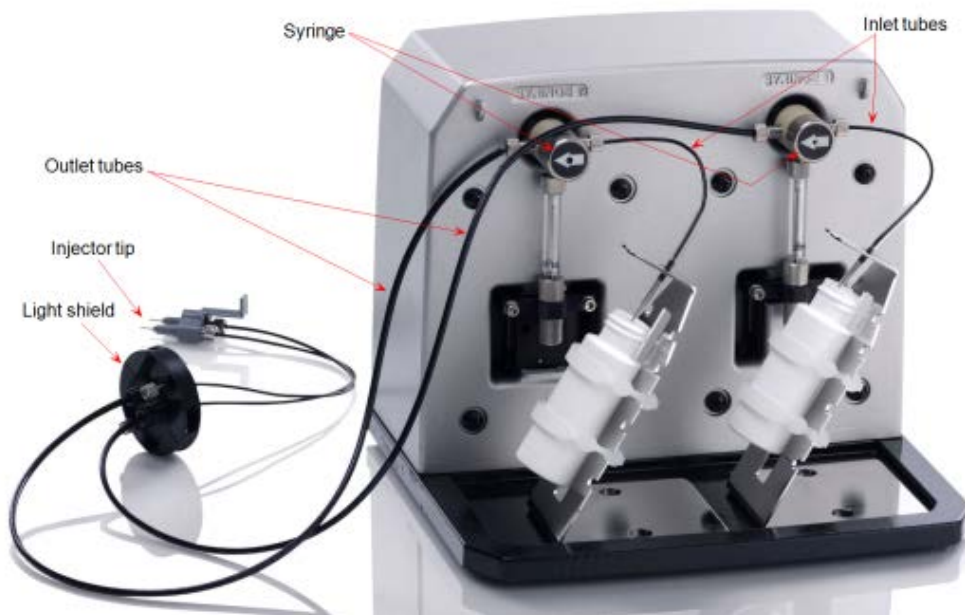

1. Open the plastic bag containing the injector tube and tips. Remove the clear plastic shrouds from the tubes.
2. Remove the two inlet tubes from their plastic canisters.
3. Identify the two syringe valves on the dispense module. Each is labeled with a left-pointing arrow.

When installing the inlet and outlet tubes, do not use any tools. Finger-tighten only!

4. Screw the fitting of one inlet tube into the right side of the Syringe 1 valve.
5. Identify the #1 outlet tube, and screw it into the left side of the Syringe 1 valve.
6. Repeat these steps to attach the inlet and outlet tubing for Syringe 2.

It is critical that the tubing is installed in the correct ports. Otherwise, injected fluid may miss the intended well.

7. Remove the round tubing feed-through cover from the top of the reader (2 screws). Store the cover and screws with the shipping hardware in case the reader needs to be shipped again.
8. Thread the injector tip holder, with outlet tubing connected to both ports, through the hole in the top of the reader.
9. Open the reader's top door, and, holding the injector tip holder by the tab, insert the injector tips into the appropriate holes inside the reader.

A magnet located between the injector tips helps to guide the tips into place and secures them in the reader.

10. Place the tubing feed-through cover over the hole in the top of the reader and finger-tighten the thumbscrews to secure it.
11. Remove the two syringes from their protective boxes. They are identical and interchangeable.
12. Install both syringes.
 - Hold the syringe vertically with the threaded end at the top.
 - Screw the top of the syringe into the bottom of the syringe valve. Finger-tighten only.
 - Carefully pull down the bottom of the syringe until it rests inside the hole in the bracket.
 - Pass a thumbscrew up through this hole and thread it into the bottom of the syringe. Hold the syringe to prevent it from rotating while tightening the thumbscrew. Finger-tighten only.

13. Locate the dispenser cable. Plug one end into the port on the left side of the dispenser. Plug the other end into the “Dispenser Port” on the rear of the reader.
14. Locate the injector tip-cleaning stylus, packaged in a small cylinder. Attach the cylinder to the back of the dispenser for storage.

10: Connect the Host Computer

The Cytation 5 is equipped with a USB port for connection to the host computer. Connect the supplied USB cable between the USB port on the back of the reader and an available USB port on the computer.

11: Install Gen5



The Cytation 5 is controlled by Gen5 software running on a host computer. There is a certain sequence of events that **must** be followed to ensure that the software is properly installed and configured. Please follow the instructions provided in *Gen5 Getting Started Guide* to install the software.

12: Turn on the Reader

If you have not already done so, turn on the reader. The reader’s power switch is located on the lower-right corner of the front panel. The reader performs a system test. When the test is completed, the reader extends the microplate carrier.

The carrier eject button, located above to the reader’s power switch, can be used to extend/retract the microplate carrier.

13: Establish Communications

Before performing this step, refer to the instructions that shipped with the USB Driver Software on the Gen5 software media to install the necessary drivers.

1. If not already done, start Gen5 and log in if prompted. The default System Administrator password is **admin**.
2. From the Gen5 main screen, select **System > Instrument Configuration** and click **Add Reader**.
3. Set the Reader Type to **Cytation 5**, and click **OK** to continue.
4. Select **Plug & Play**.

A Cytation 5 must be connected via USB to the computer and turned on to appear in the Available Plug & Play Readers list.

- To test that Gen5 can communicate with the instrument, click **Test Communications**. If the communication attempt is successful, Gen5 displays a success message. Return to Gen5's main screen.

Communication Errors

If the communication attempt is not successful, try the following:

- Is the reader connected to the power supply and turned on?
- Is the communication cable firmly attached to both the reader and the computer?
- Did you select the correct Reader Type in Gen5?
- Did you install the USB driver software?

If you remain unable to get Gen5 and the reader to communicate with each other, contact BioTek's Technical Assistance Center.

14: Install the Imager Module

Several steps are required to install the imager module.

1. Install the FireWire card and driver
2. Set up Gen5 for imaging
3. Install the objectives, LED cubes, and imaging filter cubes, and run Auto Calibration

Tools:

- Screwdriver: Desktop computer users typically need a screwdriver to install the FireWire card.
- 3/32" hex (or Allen) wrench

1. FireWire Video Card: Computer and Camera Setup

BioTek supplies the required FireWire card (PCI Express Card-IEEE-1394b) for either a desktop computer or a laptop. Follow the applicable instructions for your workplace, then install the FireWire software driver on your computer.

Desktop Computer: Install the FireWire Card

To avoid electrostatic discharge and damage to internal components, ground yourself by using wrist grounding straps or by touching a metal surface on the computer's chassis.

The following directions provide general steps for installing a PCI Express card. Talk to your company's IT representative for assistance with these steps. For more detailed help, contact BioTek TAC.

1. Turn off your computer, then remove the outside case. Depending on the computer, remove either one side of the tower or the entire cover.
2. Locate the PCI Express slot. Open the card retainer, and remove any existing graphics card (if necessary) or blank port located in the PCI Express slot.

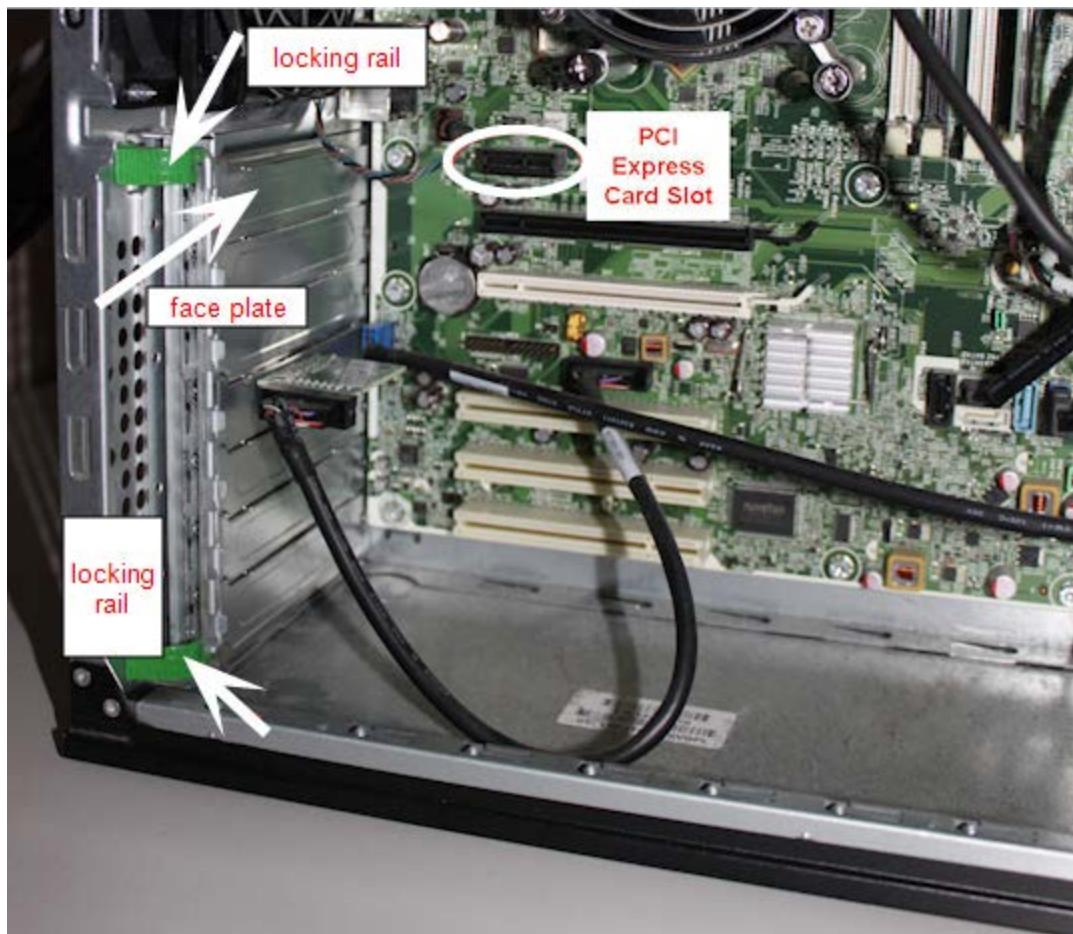

3. Insert the PCI Express card, aligning it with its slot.
4. Press the card firmly into place, and secure the card with a locking rail or screws.
5. Replace your computer's outside case, then power on the computer.

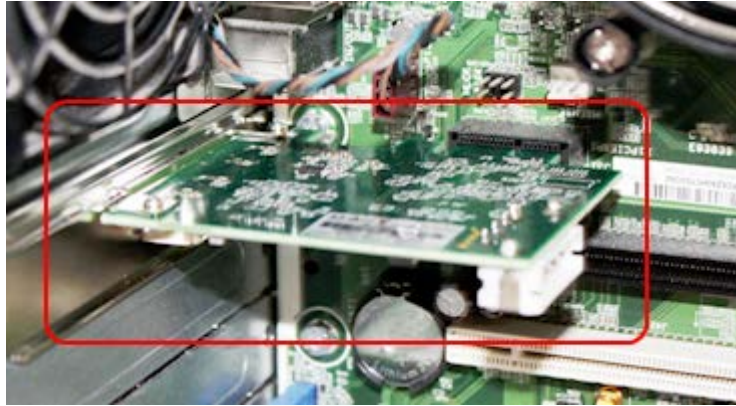

Laptop Computer: Install the FireWire Card

1. Remove the PCI Express port cover or any existing PCI Express card from your laptop.



2. Touch a metal object to discharge any static electricity.
3. Remove the PCI Express card from the packaging.
4. Attach the spacer, if required, to the FireWire PCI Express card.

The spacer does not fit tightly. Ensure that it does not fall off.

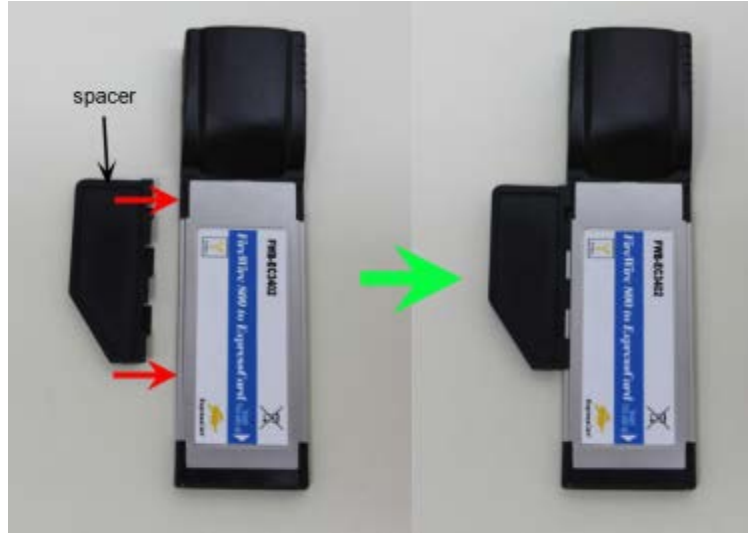

5. Insert the FireWire Express card, with the label facing up, into the appropriate slot on your laptop.
6. Plug the power cord into the card, then plug the cord into a power outlet.

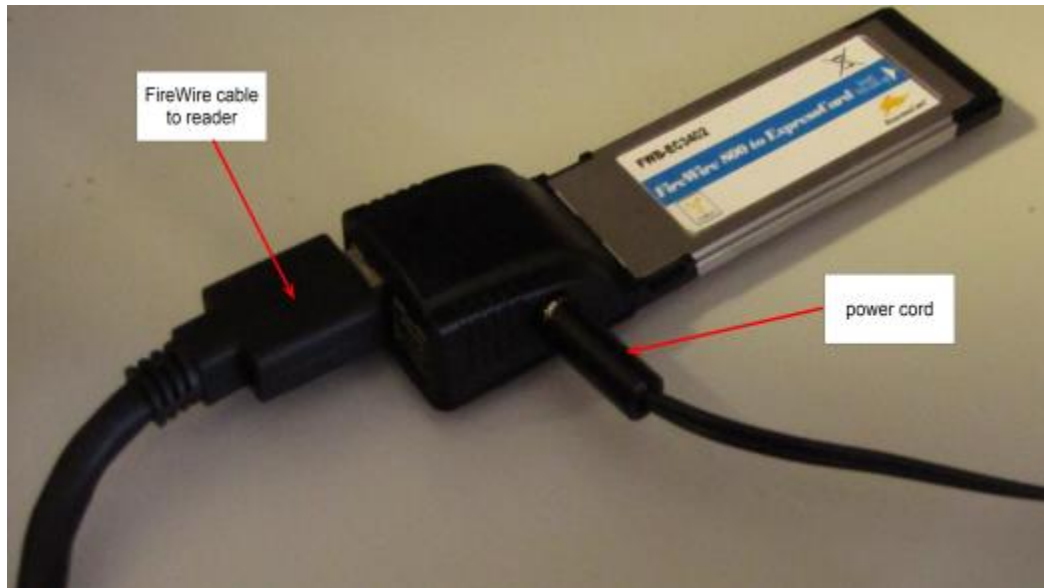

Install the FireWire Driver

You must install the PCI Express card before performing this step.

1. Navigate to the Gen5 program files on your computer, for example, C:\Program Files\BioTek\Gen5 2.07.

2. Open the Firewire Drivers folder, and then open the folder appropriate for your computer: Windows_32 (for Windows 32-bit) or Windows_64 (for Windows 64-bit).
3. In Windows 7 and higher, right-click **InstallPGRDriver.bat** and select **Run as Administrator** to run the driver installer. When the installer is finished, a message appears: "SUCCESS: Installed package <path to package>". If you do not see this message, contact BioTek TAC.
4. After installing the FireWire driver, restart your computer.
5. When the reboot process is complete, insert one end of the FireWire cable into the back of the reader, and insert the other end into the new port (in the card you installed) on your computer.

Establish Communication with the Camera

1. From the Gen5 main screen, select **System > Instrument Configuration**, select **Cytation 5**, and then click **View/Modify**.
2. Click **Camera Information**. If communication is successful, Gen5 displays information about the camera.

Troubleshooting Communication with the Camera

- Have you established communication with the instrument first?
- Did you install the FireWire software driver?
- Is the FireWire cable installed? Is your laptop card plugged into an electrical outlet?
- Is the LED light on the back of the reader lit up?
 - Red: Power to the camera from the FireWire card
 - Half-Red/Half-Green: Ready state
 - Green: Communicating/activity

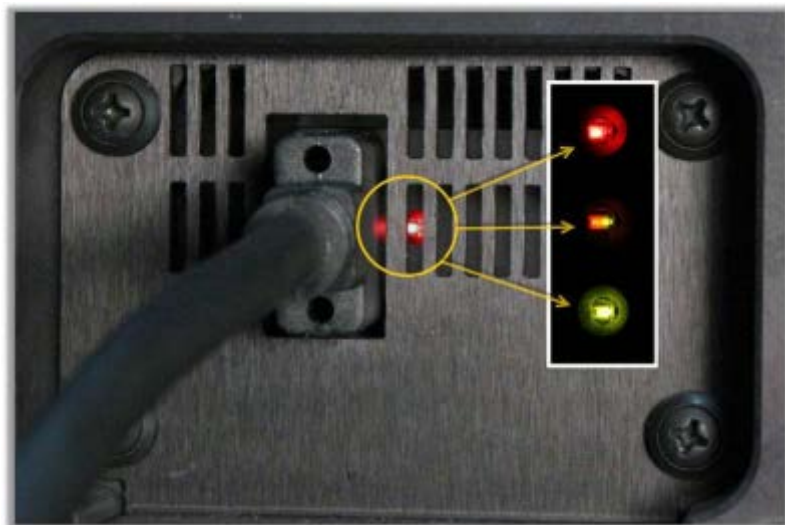

2. Set Up Gen5 for Imaging

Configuration information must be set **before** any optical components are installed. Use Gen5 to update the instrument's onboard settings. The LED cubes and imaging filter cubes must be installed with the reader **off**. Follow these installation steps in the order in which they are given.

1. In Gen5, select **System > Instrument Configuration > Cytation 5 > View/Modify > Setup**.
2. On the Imaging Configuration tab, input the objective and LED cube and imaging filter cube configurations (see **3a. Setting the Objective, LED Cube, and Imaging Filter Cube Configuration** on page 17), then click **Send Values**.

Click **Access** next to an objective position in the Objective Configuration area to lower the focusing system into the desired access position and to rotate the objective turret to the selected objective's installation position.

3. Install the objectives (see **3b. Install the Objectives** on page 17) in their defined locations.
4. Power off the instrument, and install the LED cubes and imaging filter cubes (see **3c. Install the LED Cubes and Imaging Filter Cubes** on page 17) in their defined locations. Close the side access door.

Leave Gen5 open with the Reader Setup dialog onscreen while performing the next steps.

5. Power on the instrument. After the self-test, the instrument will beep and the eject button LED will be red, indicating that the objectives must be calibrated.
6. Press the carrier eject button to stop the beeping.
7. Click **Auto Calibration**. Note that this process can take up to 15 minutes on an instrument with six objective installed.

Phase contrast components are calibrated in the factory before shipment. You do not need to run the Phase Ring Configuration and Calibration routines at this time.

3a. Setting the Objective, LED Cube, and Imaging Filter Cube Configuration

When you install an LED cube, an imaging filter cube, or an objective, you must set the cubes' and objectives' configuration before physically changing or installing them.

If you physically install an LED cube, an imaging filter cube, or an objective before setting the new configuration, the instrument may fail its self-test.

1. From the main Gen5 screen, click **System > Instrument Configuration**.
2. Select the **Cytation 5**, click **View/Modify > Setup**, and select the **Imaging Configuration** tab.
3. In the Objective Configuration area, select the objective for the position or positions you want to define, or select **None** if you are removing an objective from the instrument. Click **Access**.
4. In the LED and Imaging Filter Cube Configuration area, select the filter cube for the position you want to define, or select **None** if you are removing the filter cube from the instrument. The corresponding LED cube part number is filled in automatically.
5. Click **Send Values**.
6. For LED cube and imaging filter cube changes, follow the on-screen procedure.

3b. Install the Objectives

Before installing a 20X, 40X, or 60X objective, either phase or standard, set its correction collar to match your plate type. See the *Cytation 5 Operator's Manual* for more information and instructions.

After defining the objectives and their locations in Gen5:

1. Turn the knob on the side access door to release the latch, and open the door.



If you are installing an objective with a correction collar (i.e., a 20X, 40X, or 60X objective), be sure to grasp the objective by the adapter, not by the correction collar, to avoid changing the correction collar settings.

2. Screw each objective into its defined position. Do not overtighten the objectives.

3c. Install the LED Cubes and Imaging Filter Cubes

1. With the instrument powered off, slide the filter slide out of the instrument.
2. Place the new LED cube in the appropriate position (Position 1, 2, 3, or 4) on the filter slide.
3. Use the 3/32" hex wrench to screw the LED cube onto the filter slide.
4. Place the imaging filter cube on top of the LED cube you installed, and use the hex wrench to screw it to the LED cube.
5. Insert the LED cube's wire clip into the socket on the carrier.

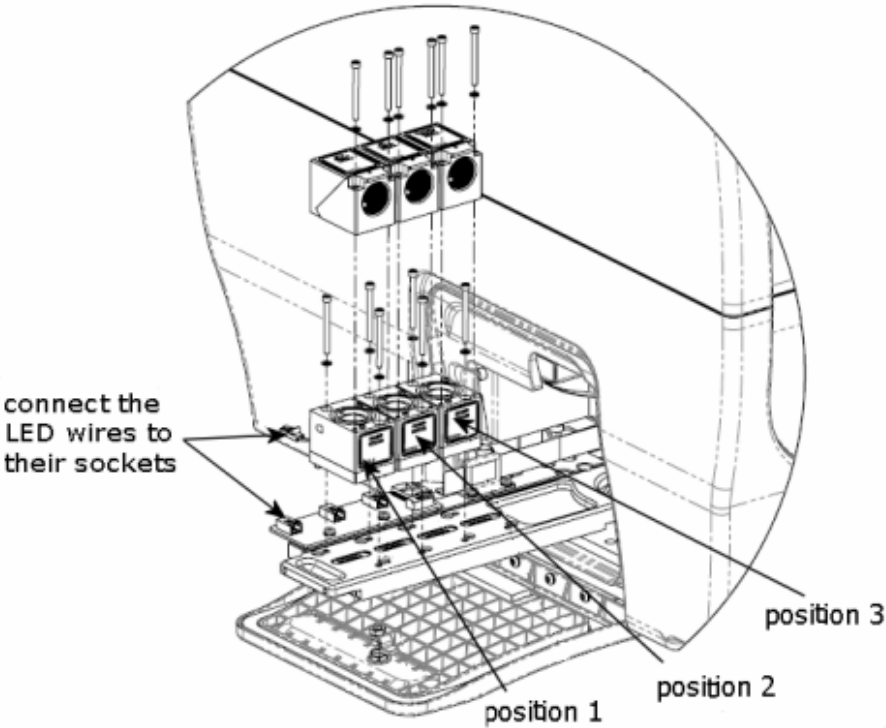

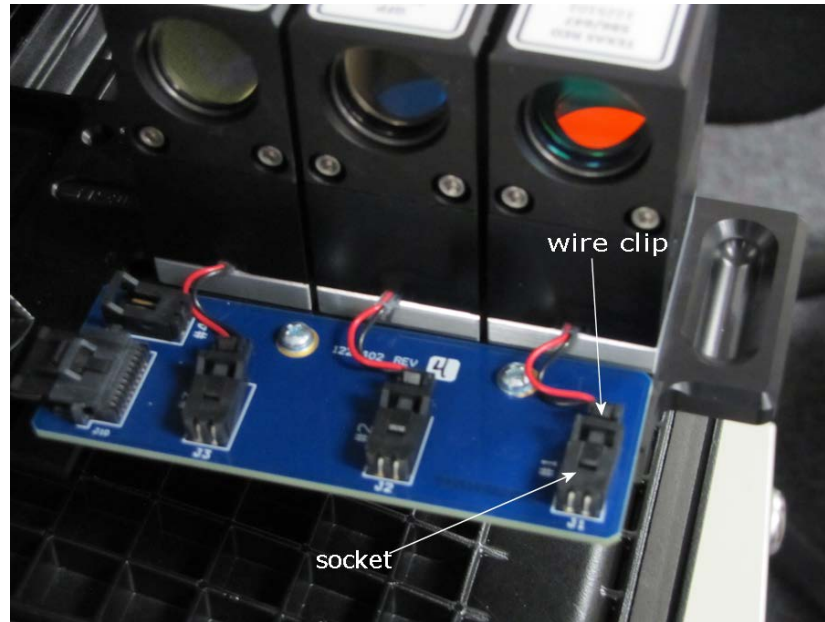

6. Slide the filter slide back into the instrument.
7. Close the side access door.

Run Auto Calibration

After you have physically installed the LED cubes, imaging filter cubes, and objectives, you must run Auto Calibration before you can use the imaging module. This process can take up to 15 minutes on an instrument with six objectives installed.

1. Turn on your instrument, and allow the self-test to run. The instrument will beep, indicating that the self-test has failed.
2. Press the carrier eject button to stop the beeping.
3. If the Reader Setup dialog is not already visible on your screen, go to **System > Instrument Configuration**, select **Cytation 5**, then click **View/Modify > Setup**.
4. On the Instrument Configuration tab, click **Auto Calibration**.
5. If you have a 40X or 60X objective installed, Gen5 prompts you to place the objective setup plate (PN 1222531) on the carrier. After you place the setup plate on the carrier, click **OK**.

After the calibration procedure is finished, the instrument is ready to use.

Troubleshooting Auto Calibration

If error messages indicate a problem with the imaging Auto Calibration process:

1. In Gen5, click **System > Instrument Configuration > Cytation 5 > View/Modify > Setup**.

2. On the Imaging Configuration tab, set the value of all objectives to **none**, and then click **Send Values**.
3. Set the correct values for all objectives, and then click **Send Values**.
4. Click **Auto Calibration**.

If problems persist, contact BioTek TAC.

15: Configure the Dispensers in Gen5

Before you use the dispenser with a BioTek reader, you must set the calibration values in Gen5.

1. In Gen5, go to **System > Instrument Configuration**, select your instrument, and click **View/Modify**.
2. Click **Setup**, and then select the **Dispenser 1 tab**.
3. On the keyboard, press CTRL+SHIFT+M to enter maintenance mode for the Dispenser 1 window.
4. Enter the syringe calibration values from the label on the rear of the dispenser box. (See Install the Dispenser.)
5. Click **Send Volumes**, and then click **Get Volumes** to verify that the entered values were sent to the instrument.
6. Select the **Dispenser 2 tab**, and repeat steps 3 through 5 for Dispenser 2.

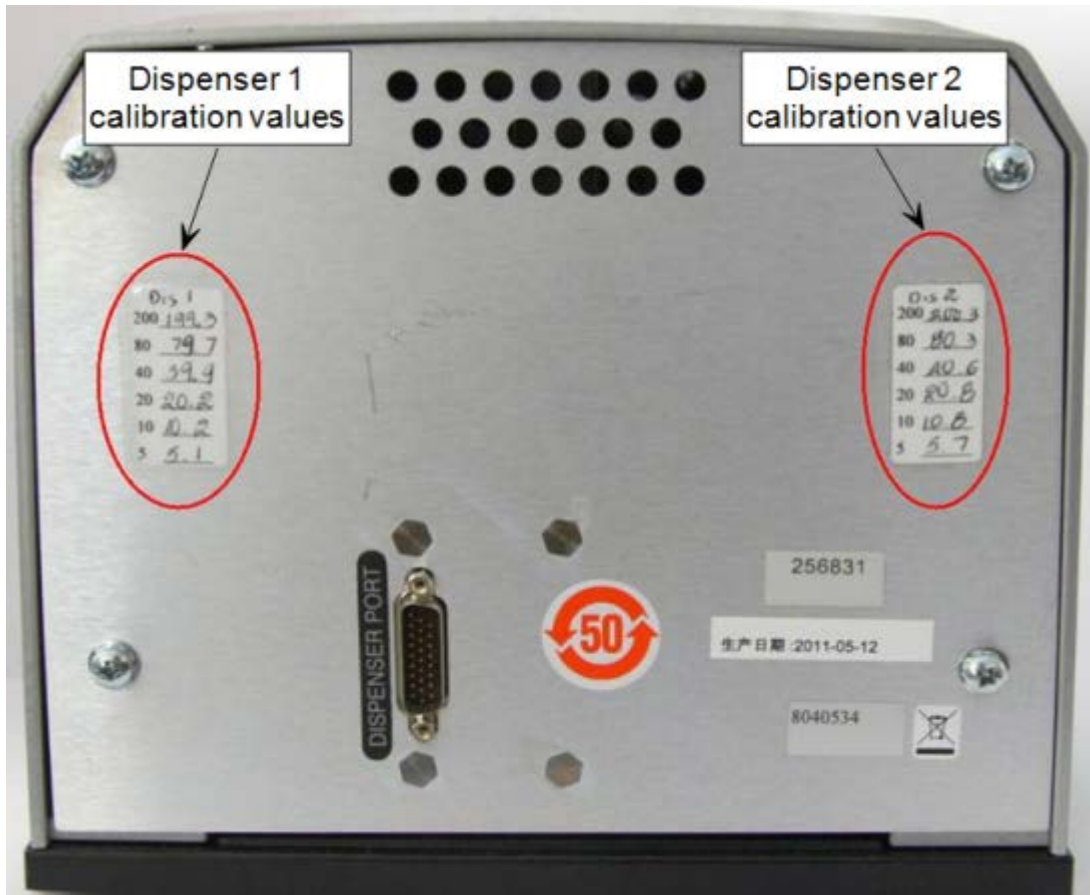

16: Test the Dispenser

1. If necessary, press the carrier eject button to extend the microplate carrier.
2. Place the tip priming trough in the rear pocket of the carrier.
3. Place the priming plate on the carrier.

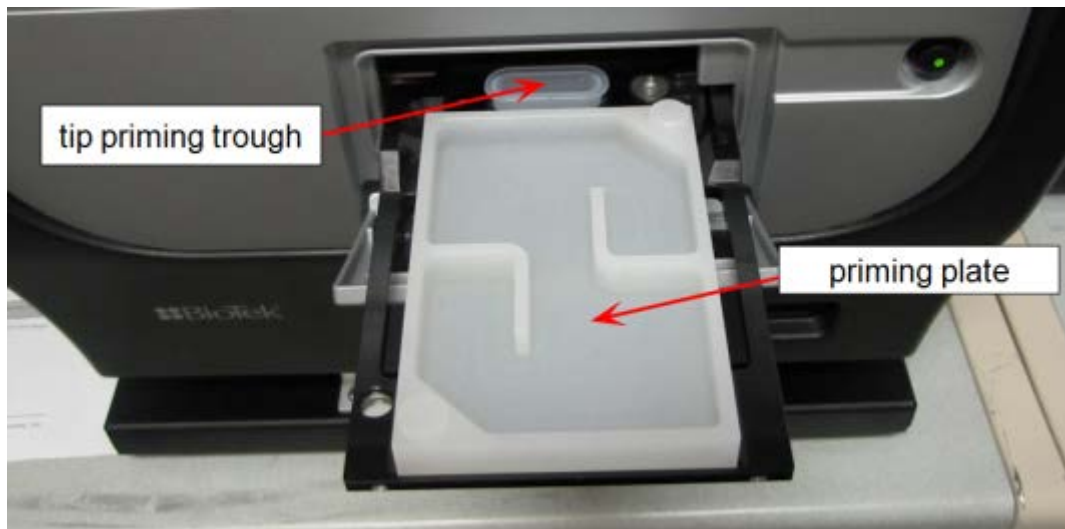

4. Fill the two reagent bottles with distilled or deionized water. Place the bottles in their holders, and place the holders directly in front of the syringes. Insert the inlet tubes into the bottles.
5. From the Gen5 main screen, select **System > Instrument Control > Cytation 5**.
6. Click the **Prime** tab.
7. With Dispenser set to **1**, set the Volume to **5000 µL** and click **Prime**.
The syringe should move down and up repeatedly, drawing fluid from the bottle. The fluid should pump through the tubing and dispense into the priming plate. Examine the fittings; no leaks should be detected. If leaks are detected, tighten all fittings and repeat the prime. If leaks are still detected, contact BioTek's Technical Assistance Center.
8. When the prime finishes, set Volume to **2000 µL** and click **Purge** to clear the fluid lines.
9. Set Dispenser to **2** and repeat steps 7 and 8.
10. When finished, remove and empty the priming plate.
11. Return to the Gen5 main screen.

17: Run a System Test

Running a system test will confirm that the reader is set up and running properly, or will provide an error code if a problem is detected.

1. Turn on the incubator:
 - From the Gen5 main screen, select **System > Instrument Control > Cytation 5**.
 - Click the **Pre-Heating** tab.
 - Enter a Requested temperature of at least 37°C and click **On**.

Wait until the incubator temperature reaches the set point before continuing.



2. Return to Gen5's main view and select **System > Diagnostics > Run System Test**. If prompted to select a reader, select **Cytation 5** and click **OK**.
3. When the test is completed, a dialog requesting additional information appears. Enter the information and click **OK**.

If a message appears that a pending system test is waiting from the initial power-up self-test, view the pending system test and repeat steps 2 and 3.

4. The results report appears. Scroll down toward the bottom; the text should read "SYSTEM TEST PASS."
 - You may wish to print the report and store it with your records.
 - The Gen5 software stores system test information in its database; you can retrieve it at any time.
5. Turn off the incubator:
 - Select **System > Instrument Control > Cytation 5**.
 - Click the **Pre-Heating** tab and click **Off**.

Repackaging and Shipping Instructions

Refer to the *Cytation 5 Operator's Manual* for complete instructions for repackaging and shipping the instrument and accessories.

	<p>If the reader and/or dispenser has been exposed to potentially hazardous material, decontaminate it to minimize the risk to all who come in contact with the reader during shipping, handling, and servicing. Decontamination prior to shipping is required by the U.S Department of Transportation regulations. See the Maintenance chapter for decontamination instructions.</p> <p>Remove the microplate and tip prime trough (if equipped) from the carrier before shipment. Spilled fluids can contaminate the optics and damage the instrument.</p>
	<p>The instrument with all available modules weighs up to 80 lbs (36.3 kg). Use two people when lifting and carrying the instrument.</p>
	<p>The instrument's packaging design is subject to change. If the instructions in this section do not appear to apply to the packaging materials you are using, please contact BioTek's Technical Assistance Center for guidance.</p> <p>Replace the shipping hardware before repackaging the reader. Please contact BioTek if you have misplaced any of these items.</p> <ul style="list-style-type: none"> • Carrier ship bracket (PN 1220510) • Carrier ship bracket screws (PN 1032190) • Top filter shipping bracket (PN 8042187) • Bottom filter slide ship bracket (PN 1380501) • Objective ship bracket (PN 1380503) <p>If you need to ship the Cytation 5 and/or the dispense module to BioTek for service or repair, be sure to use the original packaging materials. Other forms of commercially available packaging are not recommended and can void the warranty. The shipping materials are designed to be used no more than five times. If the original materials have been damaged, lost, or used more than five times, contact BioTek to order replacements.</p>

Getting Started

Overview

The Cytation 5 is a hybrid multi-mode microplate reader. Depending on the model, Cytation 5 detection modes include fluorescence intensity (FI), fluorescence polarization (FP), time-resolved fluorescence (TRF), luminescence, UV-visible absorbance, imaging, and alpha. The instrument is modular, and upgrade options are available; contact BioTek Customer Care for more information.

The reader is computer-controlled using Gen5 software for all operations, including data reduction and analysis. The Cytation 5 is robot accessible and compatible with the BioStack 3 and BioStack 4. Gen5 supports OLE automation to facilitate the Cytation 5's integration into an automated system.

Refer to the Gen5 Help system for operational and data analysis instructions.

The *Cytation 5 Operator's Manual* contains recommendations for ensuring optimum performance.

External Components



- | | |
|---|---|
| 1 | The entry for the dispense outlet tubes and injectors (if equipped) |
| 2 | Filter cube access door |
| 3 | The microplate carrier eject button |
| 4 | The light-blocking microplate carrier access door |
| 5 | The power switch |
| 6 | LED cubes, imaging filter cubes, and objectives access door |



1	Dispenser port
2	Joystick port
3	USB port
4	Power inlet
5	Gas controller hookup
6	FireWire port

Internal Components

Component	Description
Filter Cube	<p>The filter cube can contain excitation and emission filters, mirrors, and polarizing filters. Preconfigured cubes are available from BioTek, or you can change the filters and mirrors yourself.</p> <p>Note: These cubes are not to be confused with the imaging LED cubes and filter cubes.</p>
Injector System	<p>Applies to models with the dispense module. The syringes may require replacement over time. The tubing and injectors require cleaning at regular intervals.</p>
Imaging System	<p>Applies to models with the imaging module. The imaging system, comprising a CCD camera, objectives, LED cubes, and filter cubes, allows you to run experiments with imaging reads as well as view images in live mode.</p>

Filter Cube

The Cytation 5 is equipped with a filter cube that contains excitation and emission filters, mirrors, and, if required, polarizing filters. Each filter cube contains two filter sets, each of which contains one excitation filter, one mirror, and one emission filter. The filter cube is accessed through a hinged door on the front of the instrument.

Synergy H1 filter cubes are interchangeable with the filter cubes for the Cytation 5.

Do not open the door to access the filter cube during instrument operation. Doing so may result in invalid data.

Define the Filters

Gen5 keeps track of each cube's contents and communicates this information to the instrument during operation. You must define characteristics for your filter cube(s) in the Gen5 Filter Cube Table (**System > Instrument Configuration > Setup**).

- Select **Band Pass**, **Long Pass**, or **Short Pass**, as appropriate for each filter type.
 - **Band Pass**, a standard interference filter with a defined central wavelength and bandwidth.
 - **Long Pass**, cutoff filters that transmit longer wavelengths and block shorter wavelengths.
 - **Short Pass**, cutoff filters that transmit shorter wavelengths and block longer wavelengths.
- Select **PLUG** to indicate the presence of a plug.
- Select **HOLE** to indicate an empty location.

Configuring the System for Luminescence Measurements

If your tests require that light emitted from the samples remain unfiltered, the Emission filter position in the filter cube should be empty.

1. Click **System > Optics Library > Filter Cubes**.
2. Select the checkbox in the On Site column for the filter cubes you have available.

Injector System

The tubing and injectors should be cleaned at least every three months.

Inspect the injector system daily for leaks, preferably immediately after priming and whenever tubing changes have been made.

If a syringe is leaking, it may need to be replaced.

Dispense Module

The dispense module sits on top of the reader or gas controller and pumps fluid from the reagent bottles to injector located inside the instrument. Fluid is injected into one well at a time. The injectors support plate types from 6- to 384-well plates.

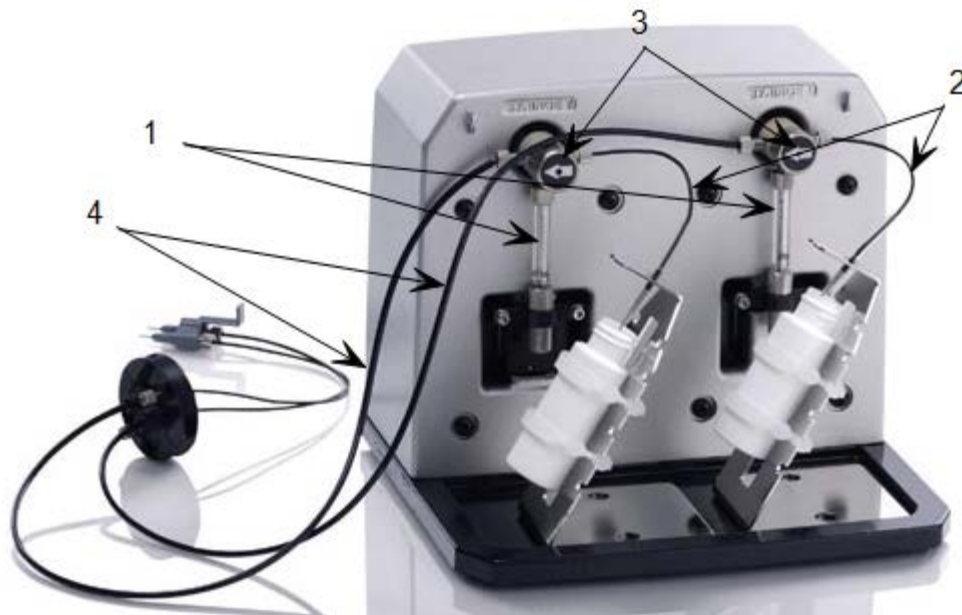

- 1 Two 250 μ L syringes draw fluid from the supply bottles
- 2 Inlet tubes transport fluid from the supply bottles to the syringes. These tubes are short pieces of opaque PTFE (Teflon) tubing connected to stainless-steel probes on one end and threaded fittings on the other end.
- 3 Solenoid valves allow the fluid drawn from the supply bottles by the syringe pumps to flow into the outlet tubes.
- 4 Outlet tubes transport fluid from the syringes into the instrument, through the tubing ports on the Cytation 5's top cover. The outlet tubes are opaque PTFE tubes with threaded fittings on each end.

Dispense Module Components and Materials Composition

Continuous contact with harsh chemicals is not recommended. Always rinse the fluid path with deionized water after contact with any strong acid, base, or solvent.

Components	Material Composition
Tubing, syringe fittings	PTFE (polytetrafluoroethylene)
Injector tips	315 stainless steel
Injector body	PVC (polyvinyl chloride)
Priming plate and trough	Polypropylene
Valve diaphragms	Ethylene propylene (EPDM)
Valve body	PEEK (polyether ether ketone)
Syringe barrel	Borosilicate glass

Priming the Injector System

Before running a dispense assay, prime the system with the reagent or dispensing fluid. In addition, tip priming can be performed at the start of an assay and, sometimes, just before each dispense to a well. The tip prime compensates for any fluid loss at the injector tip due to evaporation since the last dispense. All priming activities are controlled via Gen5.

If the injector system is not primed adequately, air bubbles can get trapped in the system and affect injection volumes. Air bubbles in the system can also result in fluid spraying or scattering inside the reader.

Both types of primes require a fluid reservoir to be present on the microplate carrier.

- The priming plate is placed on the microplate carrier for a Prime operation (to prime the dispense system with fluid).
- The tip priming trough is placed in the rear pocket of the carrier, and is used for performing the Tip Prime before dispensing. The trough holds up to 1.5 mL of liquid and must be periodically emptied and cleaned by the user.

Do not perform tip priming when using tall plates. Generally, plates with fewer than 96 wells are too tall for error-free tip priming; and, tip priming is rarely required for these larger-volume plates.

The priming tray should be empty before priming and contain fluid after priming.

Imaging System

Instruments with the imaging module can perform image reads, view and capture images in manual mode, and save the images for later analysis. The imaging module comprises up to four LED cubes and four imaging filter cubes, up to six objectives, and a CCD digital camera, which captures images directly through the selected objective and filter cube assembly. The imaging module supports two modes, manual mode and experiment mode.

Camera

Gen5 controls the CCD camera via FireWire. Using Gen5, you can focus the camera, determine exposure settings, and capture images.

LED Cubes and Imaging Filter Cubes

The LED cubes and imaging filter cubes are located behind a door on the left side of the instrument and are user-changeable.

Objectives

The objectives are located next to the LED cubes and imaging filter cubes in an objective turret. Gen5 supports the installation of up to six user-changeable objectives.

Imaging Modes

The Gen5 imaging module provides two modes of use: manual and experiment.

- **Manual mode** allows you to view, capture, and analyze images outside of a protocol or experiment. Images are displayed in real time. You can also retrieve previously captured and saved images to analyze in manual mode.
- In **experiment mode**, you can perform an image read step as an endpoint read or include it in a kinetic block in your procedures and experiments. An imaging procedure can include additional steps (as supported by the reader), such as dispense, shake, incubate, and different detection modes.

Change the Virtual Memory Settings

You may find that you need more hard disk space than is allocated by default. For example, running a multiplate experiment, imaging all 96 wells in a 4x4 montage in three colors will require an increase of virtual memory. Without this change, the message, "This procedure may require that you increase the size of the virtual memory in Windows," may appear. In this case, please consult with your IT group to increase virtual memory, using the following instructions to prevent errors:

1. From the Windows Start menu, go to **Control Panel** and select **System**.
2. In the left pane, select **Advanced system settings**.
3. In the System Properties dialog, on the Advanced tab in the Performance area, click **Settings**.
4. In the Performance Options dialog, on the Advanced tab, in the Virtual Memory area, click **Change**.
5. Clear **Automatically manage paging file size for all drives**, if it is selected.
6. Select **Custom Size**, enter the following minimum and maximum values, and then click **OK**:
 - Initial size: 10 GB
 - Maximum size: 20 GB

You may need to restart your computer for the change to take effect.

Shaking System

Three shake modes are available for selection in Gen5: Linear, Orbital, and Double Orbital. A linear shake simply moves the carrier's y-axis back and forth in a line. An orbital shake moves both carrier axes to scribe a circle. With double orbital, the carrier scribes a figure-eight pattern.

For any mode, a slider bar in the software allows you to adjust the shake frequency from "Slower" to "Faster." With each adjustment, the corresponding cycles per minute (CPM) is displayed.

For either orbital mode, you can further expand the frequency options by clicking a Slow or Fast button.

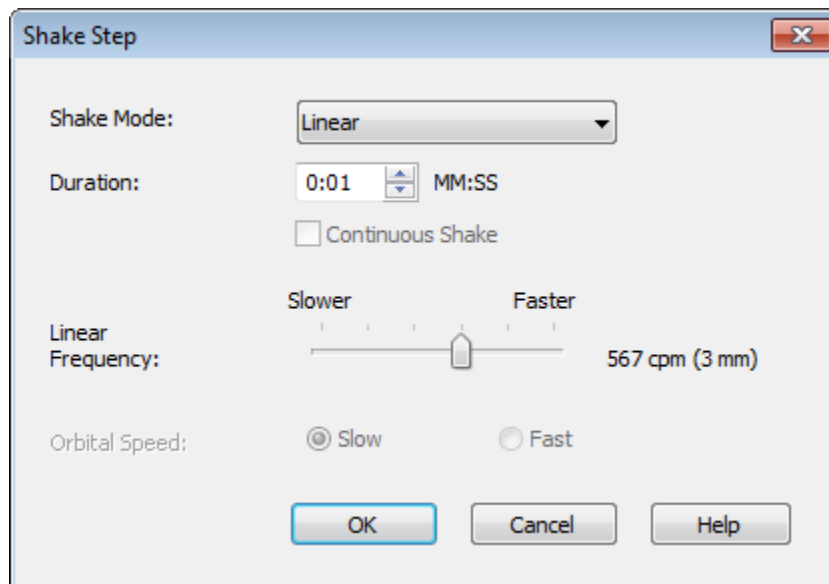

Carrier Shake Definitions

Shake Type	Displacement (mm/steps)	Period (msecs)	Frequency (Hz)	CPM	Ramp Profile
Linear	1/6	54.8	18.3	1096	13
	2/12	82.0	12.2	731	14
	3/18	105.8	9.5	567	15
	4/24	121.6	8.2	493	16
	5/30	146.3	6.8	410	17
	6/36	166.9	6.0	360	18
Slow orbital	1/6	107.3	9.3	559	19
	2/12	164.4	6.1	365	20
	3/18	212.5	4.7	282	21
	4/24	253.5	3.9	237	22
	5/30	292.1	3.4	205	23
	6/36	334.2	3.0	180	24
Fast orbital	1/6	74.3	13.4	807	25
	2/12	109.6	9.1	548	26
	3/18	141.3	7.1	425	27
	4/24	169.0	5.9	355	28
	5/30	195.4	5.1	307	29
	6/36	222.8	4.5	269	30

Maximum Shaking Amplitude Based on Assay Volume and Plate Type

If the wells of a microplate are almost full, vigorous shaking can result in spillage inside the instrument. The following table is designed to help avoid this issue. Find your microplate type and sample volume to ascertain the acceptable shake amplitude on your instrument.

Sample Volume	Linear	Orbital Slow	Orbital Fast	Double Orbital Slow	Double Orbital Fast
6-well Microplate					
0–3 mL	1–6 mm	1–6 mm	1–6 mm	1–6 mm	1–6 mm
3–4 mL	1–6 mm	1–6 mm	1–6 mm	1–6 mm	1 mm

Sample Volume	Linear	Orbital Slow	Orbital Fast	Double Orbital Slow	Double Orbital Fast
4–5 mL	1 mm	1–6 mm	1–6 mm	1–6 mm	1 mm
5–7 mL	1 mm	1–6 mm	1–3 mm	1 mm	No
7–8 mL	1 mm	No	1–3 mm	No	No
9 mL	1 mm	No	No	No	No
12-well Microplate					
0–1.5 mL	1–6 mm	1–6 mm	1–6 mm	1–6 mm	1–6 mm
1.5–2.5 mL	1–2 mm	1–6 mm	1–6 mm	1–6 mm	1 mm
2.5–3 mL	1–2 mm	1–6 mm	No	No	1 mm
3–4 mL	No	1–6 mm	No	No	No
24-well Microplate					
0–0.75 mL	1–6 mm	1–6 mm	1–6 mm	1–6 mm	1–6 mm
0.75–1 mL	1 mm	1–6 mm	1–6 mm	1–6 mm	1–6 mm
1–1.5 mL	1 mm	1–6 mm	1–6 mm	1–6 mm	No
1.5–2 mL	1 mm	1–6 mm	No	1–6 mm	No
48-well Microplate					
0–0.5 mL	1–6 mm	1–6 mm	1–6 mm	1–6 mm	1–6 mm
0.5–1 mL	1 mm	1–6 mm	1–6 mm	1–6 mm	1–6 mm
1–1.3 mL	No	1–6 mm	1–6 mm	1–6 mm	No
96-well Microplate					
0–0.25 mL	1–6 mm	1–6 mm	1–6 mm	1–6 mm	1–6 mm

Gen5 Software

BioTek Gen5 software supports all Cytation 5 reader models. Use Gen5 to control the reader, the imaging module (if equipped), the dispense module (if equipped), and the stacker (if equipped); perform data reduction and analysis on the measurement values; print or export results; and more. This section provides brief instructions for working with Gen5 to create protocols and experiments and read plates. Refer to the Gen5 Help system for more information and to learn about the various license levels available.

Define the Fluorescence Filter Cube

For "F" models (filter fluorescence), the filter cube's characteristics must be entered into Gen5 and downloaded to the reader. Perform these steps before using the reader for the first time, and again if you change the filter cube's contents or switch to a different cube.

1. Select **System > Instrument Configuration**. Highlight the **Cytation 5**, and click **View/Modify**.
2. Click **Setup**, and then click the **Filter Cube** tab.
3. Enter a name for the filter cube.
4. Select **Fluorescence Polarization Cube**, if applicable.
5. Enter a filter set name for Filter Set 1, and define the excitation, mirror, and emission settings:
 - **Band Pass**, a standard interference filter with a defined central wavelength and bandwidth.
 - **Long Pass**, cutoff filters that transmit longer wavelengths and block shorter wavelengths.
 - **Short Pass**, cutoff filters that transmit shorter wavelengths and block longer wavelengths.
 - **Plug** indicates the presence of a plug.
 - **Hole** indicates an empty location.
6. Repeat step 5 for Filter Set 2.

Protocols and Experiments

In Gen5, a protocol contains instructions for controlling the reader and (optionally) instructions for analyzing the data retrieved from the reader. At a minimum, a protocol must specify the procedure for the assay you wish to run. After creating a protocol, create an experiment that references the protocol. You'll run the experiment to read plates and analyze the data.

These instructions briefly describe how to create a protocol in Gen5. See the Gen5 Help system for complete instructions.

1. Open a new protocol.
2. Open the Procedure dialog. If prompted to select a reader, select the **Cytation 5** and click **OK**.
3. Select a Plate Type.

Gen5 stores measurements and other characteristics for individual plate types in a database. It is essential that you select (or define) the plate type to match the assay plate. Otherwise, results may be invalid.

For imaging reads, you must also define the Bottom Elevation parameter for the plate or slide. If the relevant measurements are not defined, Gen5 will not allow the objective to move closer than 1 mm from the bottom of the carrier, thus disabling Cytation 5's focus capabilities.

4. Add steps to the procedure for shaking or heating the plate, dispensing fluid, reading the plate, and more. Click **Validate** to verify that the reader supports the defined steps, and then click **OK**.

Optionally, perform the next steps to analyze and report the results:

5. Open the Plate Layout dialog and assign blanks, samples, controls, and/or standards to the plate.
6. Open the Data Reduction dialog to add data reduction steps. Categories include Transformation, Well Analysis, Curve Analysis, Cutoff, and Validation.
7. Create a report or export template via the Report/Export Builders.
8. Select **File > Save** and give the file an identifying name.

These instructions briefly describe how to create an experiment and then read a plate in Gen5. See the Gen5 Help system for complete instructions.

1. Open a new experiment.
2. Select the desired protocol and click **OK**.
3. Select a plate in the menu tree and read it.
4. When the read is complete, measurement values appear in Gen5. Select the desired data set from the Data list.
5. Select **File > Save** and give the file an identifying name.

Imaging Module: Manual Mode

Applies only to models with the imaging module.

The following sections **briefly** describe how to use the Gen5 imaging module in manual mode. See the Gen5 Help for more complete instructions and descriptions of these features.

Focusing the Camera

1. From the Task Manager, select **Read Now > Run Imager Manual Mode**.



Alternatively, from the main Gen5 screen, click  .

2. Click **Find Image**. Gen5 automatically sets the exposure and focuses on the image. If the displayed image requires additional fine-tuning:
 - Click **Auto Expose**, or manually adjust the Exposure settings until you see an image.

- Click **Auto Focus**, or click the arrow buttons until the image is in focus.
- Repeat these two steps until the image is exposed and focused to your liking.

Capture and Save an Image

When you have a satisfactory image, you can capture and save it for later analysis.

1. When an image in the Capture dialog is in focus, click  to capture it.
2. To save the captured images, click Review/Save.
3. Click  to adjust the brightness and contrast adjustments or  to manually align overlaid images to compensate for pixel shift, then click **Save**.

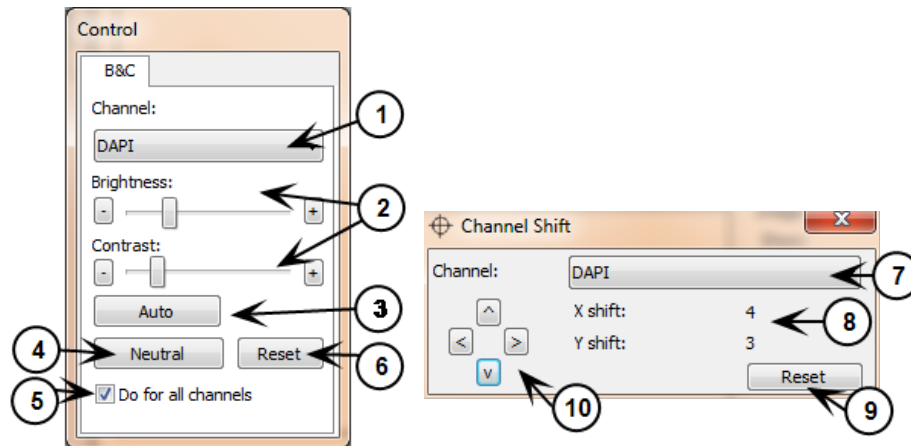

#	Description
1	Select a color channel
2	Use the sliders or +/- buttons to adjust brightness and contrast
3	Have Gen5 automatically adjust brightness and contrast
4	Set to neutral settings (similar to the default settings)
5	If selected, changes to brightness and contrast will apply to all color channels of the image
6	Reset to default settings
7	Select a color channel
8	Gen5 displays the number of pixels the channel is shifted
9	Reset to default settings
10	Adjust the shift using the arrows

Adjustments made using the B&C (brightness and contrast) and Channel Shift dialogs are for display purposes only; the changes do not affect the data measurements from the images.

Analyze Captured and Saved Images

1. With your captured or saved images displayed in the left panel of the Capture dialog, click **Review/Save**.
2. If necessary, adjust the brightness and contrast of the image.
3. Click **Analyze**.
4. In the Analyze Tool, select which type of analysis you want to perform and define the parameters for the analysis, then click **Start**. The results are displayed in the right pane.

Imaging Module: Experiment Mode

Applies only to models with the imaging module.

The following sections **briefly** describe how to use the Gen5 imaging module in experiment mode. See the Gen5 Help for more complete instructions and descriptions of these features.

Perform an Image Read

You can create an Image Read step to be used alone or in combination with the monochromator- or filter-based optics of the Cytation 5.

1. Create a new protocol and select the Plate Type.
2. Create a read step, and select **Image** as the Read Method.
3. (Optional) Enter a step label or unique name for this step. Data sets of the reading results will use the label in online views, reports, and export files.
4. Select the objective.
5. Define whether to read a full plate or specific wells.
6. Define up to four channels to read:
 - a. Defining the color filter.
 - b. Select whether exposure is automatic or defined.
 - c. Define which wells are used for auto-exposure for each channel, if applicable.
 - d. Define focus and exposure options, if needed.
7. Define the horizontal and vertical offset from the center of the well.
8. Select whether to create a single image for each well, an image montage, or an image Z-stack.
9. Define advanced options, if needed.

After you have defined and saved the protocol, you can create an experiment and read the plate:

1. Create an experiment using an existing protocol.
2. Select the protocol you created with the imaging read step, and click **OK**.
3. Select a plate in the menu tree and read it.
4. When prompted, give the file an identifying name.
5. When the read is complete, images and measurement values appear in Gen5. Select the desired data set from the Data list.

Using the Slide Holder

Manual Mode

1. When prompted upon entering manual mode, select one of the slide holders as your plate type.
2. The slide holder plate map contains two well positions that correspond with the two slide locations on the slide holder. Select the well position that contains the slide you want to image.
3. By default, the carrier moves so that the middle of the selected slide position is below the objective. However, the sample on your slide may be in a different location on the slide. To find the sample:
 - a. Select your lowest-power objective.
 - b. Select either **Small step** or **Large step**, then use the arrow buttons to move the slide around until you find your sample. The cross in the slide display to the right of the arrow buttons shows the general position of the image in relation to the slide. The back arrow to the left of the slide display shows the direction that the slide enters the read chamber.



4. After you find your sample, you can change to a higher-power objective, if desired, or define a Read step in a protocol using the x- and y-coordinates of your sample, which are displayed below the Well button.

Experiment Mode

1. In an experiment, select one of the slide holders as the plate type, and create an Image read step.
2. Clear the **Auto** box to turn off Auto Exposure, then click  to enter manual mode.
3. Follow steps 2 and 3 in the manual mode procedure (above) to find your samples, then click **Save settings**. Gen5 imports your exposure settings

and the values for Horizontal and Vertical offset from the center of the well to your read step.

4. Select **Auto** to turn Auto Exposure back on. Gen5 will auto-expose your image, retaining the well offset imported from manual mode.

You can also enter the values for Horizontal and Vertical offset from center of well if you had determined them during previous testing.

Dispense Module Control

This section applies only to models with injectors.

Gen5 is used to perform several dispense functions, such as initialize, dispense, prime, and purge. The Prime and Purge functions are introduced here. See the Gen5 Help system for more information.

Priming and purging routines are used to clean the fluid paths.

Prime

Before running an experiment with a dispense step, prime the system with the fluid to be used.

1. Place the priming plate on the carrier.
2. Fill the supply bottle with a sufficient volume of the fluid to be used for the prime and the assay. Insert the appropriate inlet tube into the bottle.
3. In Gen5, select **System > Instrument Control > Cytation 5** and click the **Prime** tab.
4. Select the Dispenser number (1 or 2) associated with the supply bottle.
5. Enter the Volume to be used for the prime. The minimum recommended prime volume is 2000 μL .
6. Select a prime Rate, in $\mu\text{L}/\text{second}$.
7. Click **Prime** to start the process.
8. When finished, carefully remove the priming plate from the carrier and empty it.

If the priming plate is empty, the prime volume was too low.

Purge

To save reagent, Gen5 provides the option to purge fluid from the system back into the supply bottle.

1. In Gen5, select **System > Instrument Control > Cytation 5** and click the **Prime** tab.
2. Select the Dispenser number (1 or 2) associated with the supply bottle.
3. Enter the desired purge Volume in μL (e.g., 2000).
4. Select a prime Rate in $\mu\text{L}/\text{second}$.
5. Click **Purge** to start the process.

Maintenance

Preventive Maintenance

A general preventive maintenance regimen for all Cytation 5 models includes periodically cleaning all exposed surfaces and inspecting/cleaning the objectives, emission and excitation filters, and mirrors (if used).

For models with the external dispense module, additional tasks include flushing/purging the fluid path and cleaning the tip prime trough, priming plate, supply bottles, dispense tubing, and injectors.

Daily Cleaning for the Dispense Module





To ensure accurate performance and a long life for the dispense module and injectors, flush and purge the fluid lines with deionized (DI) water every day or after completing an assay run, whichever is more frequent. Some reagents may crystallize or harden after use and clog the fluid passageways. Take special care when using molecules that are active at very low concentrations (e.g., enzymes, inhibitors). Remove any residual reagent in the dispense lines using a suitable cleaning solution (review the reagent's package insert for specific recommendations).



Flushing the tubing at the end of each day, letting the DI water soak overnight, and then purging the lines at the beginning of each day ensures optimal performance of the dispense system. BioTek recommends performing a visual inspection of the dispense accuracy before running an assay protocol that includes dispense steps.

Models with injectors: Accumulated algae, fungi, or mold may require decontamination. See the *Cytation 5 Operator's Manual* for complete decontamination instructions.

Warnings and Precautions

Read the following before performing any maintenance procedures:

	Warning! Internal Voltage. Turn off and unplug the instrument for all maintenance and repair operations.
	Important! Do not immerse the instrument, spray it with liquid, or use a "wet" cloth on it. Do not allow water or other cleaning solution to run into the interior of the instrument. If this happens, contact BioTek's Technical Assistance Center.
	Important! Do not apply lubricants to the microplate carrier or carrier track. Lubricant attracts dust and other particles, which may obstruct the carrier path and cause errors.
	Warning! Wear protective gloves when handling contaminated instruments. Gloved hands should be considered contaminated at all times; keep gloved hands away from eyes, mouth, nose, and ears.

	<p>Warning! Mucous membranes are considered prime entry routes for infectious agents. Wear eye protection and a surgical mask when there is a possibility of aerosol contamination. Intact skin is generally considered an effective barrier against infectious organisms; however, small abrasions and cuts may not always be visible. Wear protective gloves when handling contaminated instruments.</p>
	<p>Caution! The buildup of deposits left by the evaporation of spilled fluids within the read chamber can impact measurements. Be sure to keep System Test records before and after maintenance so that changes can be noted.</p>
	<p>Warning! The instrument with all available modules weighs up to 80 lbs. (36.3 kg). Use two people when lifting and carrying the instrument.</p>

Clean Exposed Surfaces

Exposed surfaces may be cleaned (not decontaminated) with a cloth moistened (not soaked) with water or water and a mild detergent. You'll need:

- Deionized or distilled water
 - Clean, lint-free cotton cloths
 - Mild detergent (optional)
 - Canned air
1. Turn off and unplug the instrument.
 2. Moisten a clean cotton cloth with water, or with water and mild detergent. **Do not soak the cloth.**
 3. Wipe the plate carrier and all exposed surfaces of the instrument.
 4. Instruments with imaging capability: Used canned air to blow debris from the aperture on the carrier. Do not wipe with liquid, which can seep inside aperture's glass plates and impact imaging reads.



5. Wipe all exposed surfaces of the dispense module (if used).
6. Wipe all exposed surfaces of the gas controller module (if used).
7. If detergent was used, wipe all surfaces with a cloth moistened with water.
8. Use a clean, dry cloth to dry all wet surfaces.

Models with a dispenser: If the Tip Priming Trough overflows or other spills occur inside the instrument, wipe the carrier and the surface beneath the carrier with a dry cotton cloth. The internal chamber and probes are not customer-accessible. If overflow is significant, contact BioTek's Technical Assistance Center with any questions about your particular model.

Inspect/Clean Mirrors

Applies only to Cytation 5 models with filter-based fluorescence capabilities.

We recommend inspecting/cleaning the mirrors and polarizing filters (if equipped) annually, especially if the filter cube has been opened or changed.

These optical elements are delicate and should be handled as carefully as possible. The glass and anti-reflective (AR) coated surfaces will be damaged by any contact, especially by abrasive particles. **In most cases, it is best to leave minor debris on the surface.** However, if performance indicators or obvious defects in the mirrors or filters suggest cleaning them, here are some guidelines:

- Use of oil-free dry air or nitrogen under moderate pressure is the best method for removing excessive debris from an optical surface. If the contamination is not dislodged by the flow of gas, please follow the cleaning instructions below.

- The purpose of the cleaning solvent is only to dissolve any adhesive contamination that is holding debris on the surface. The towel needs to absorb both the excessive solvent and entrap the debris so that it can be removed from the surface. Surface coatings on dichroics are typically less hard than the substrate. It is reasonable to expect that any cleaning will degrade the surface at an atomic level. Consideration should be given as to whether the contamination in question is more significant to the application than the damage that may result from cleaning the surface. In many cases, the AR coatings that are provided to give maximum light transmission amplify the appearance of contamination on the surface.

Materials

- 7/64" hex key
- Linen or cloth gloves
- Anhydrous reagent-grade ethanol
- Kimwipes
- Magnifying glass
- 100% pure cotton balls (for the polarizing filters)

Procedure

1. Open the access door on the front of the instrument and slide the filter cube straight out of its compartment.
2. Set the filter cube on the work surface. Using a 7/64" hex key, remove the screw and washer located between the emission filter positions.



3. Carefully lift the filter cube top from the cube.
4. Wearing linen or cloth gloves, grasp the mirror by its edges and lift it out of the cube.

The mirrors are seated on a shelf in the bottom of the cube and are not secured in place.

5. Wet absorbent towels such as Kimwipes, **not** lens paper, with anhydrous reagent-grade ethanol. Wear gloves or use enough toweling so that solvents do not dissolve oils from your hands that can seep through the toweling onto the coated surface.
6. Drag the trailing edge of the ethanol-soaked Kimwipe across the surface of the mirror, moving in a single direction. A minimal amount of pressure can be applied while wiping. However, too much pressure will damage the mirror.
7. Use the magnifying glass to inspect the surface; if debris is still visible, repeat with a new Kimwipe.
8. To replace the mirror, hold it by its edges, turn it so that its label is face-up and readable, and place it on the shelf in the filter cube.

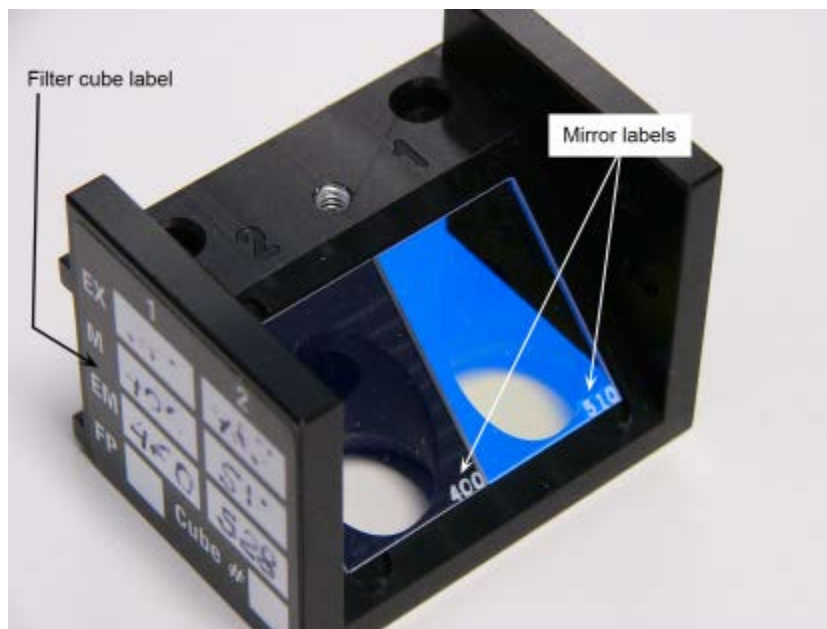

9. Place the filter cube top back onto the cube and replace the screw and washer.
10. When finished, reinstall the filter cube in the reader.

Inspect/Clean Excitation and Emission Filters

Applies only to Cytation 5 models with filter-based fluorescence capabilities.

Laboratory air is used to cool the flash bulb, and the filter cubes can become dusty as a result. Filters should be inspected and cleaned at least every three months. You'll need:

- Isopropyl, ethyl, or methyl alcohol
- 100% pure cotton balls or high-quality lens-cleaning tissue
- Cloth gloves
- Magnifying glass

Do not touch the filters with your bare fingers!

1. Open the access door on the front of the instrument. Slide the filter cube out of its compartment.
2. Inspect the glass filters for speckled surfaces or a “halo” effect. This may indicate deterioration due to moisture exposure over a long period of time.

If you have any concerns about the quality of the filters, contact your BioTek representative.

3. Using cotton balls or lens-cleaning tissue moistened with a small amount of high-quality alcohol, clean each filter by lightly stroking its surface in one direction.
4. Use a magnifying glass to inspect the surface; remove any loose threads left from the cotton ball.
5. Replace the filter cube and close the door.

Clean the Objectives

Applies only to models with the imaging module.

The objectives used in the Cytation 5 should be cleaned when necessary using optical-grade swabs or lens paper moistened with lens cleaning solution or deionized water. **Do not rub the lens.**

Materials

- Air puffer
- Tweezers
- Magnifying glass
- Lens cleaning tissue
- Optical-grade swabs
- Cleaning solvent

Recommended Cleaning Solvents	Non-recommended Cleaning Solvents
HyperClean (hexamethyldisiloxan and ethanol), available from Olympus	Methyl ethyl ketone (MEK)
Isopropyl alcohol, 70%/30% with deionized water	Dimethyl ketone (acetone)
Methyl alcohol, 70%/30% with deionized water	
Ethyl alcohol, 70%/30% with deionized water	

1. From the Gen5 main screen, go to **System > Instrument Configuration**, select **Cytation 5**, click **View/Modify > Setup**.
2. In the Objective Configuration area in the Imaging Configuration tab, click **Access** next to the desired objective to rotate the objective turret to the access position for that objective.
3. Open the side door of the instrument. Grasp one of the objectives, unscrew it from the objective turret, and remove it from the instrument.
4. Inspect the lens, using a magnifying glass if necessary, to determine if there is dirt or dust present. If so, use a blower or a small paintbrush to remove any dirt and dust.

Any dirt or dust on the surface of the lens can cause extensive damage if dragged across the surface.

5. Soak either an optical-grade swab or a piece of lens cleaning tissue wrapped around tweezers in lens cleaning solvent or deionized water.
6. Hold the swab or tissue-wrapped tweezers still and rotate the objective's lens around it.
7. Dry the lens immediately with a clean lens tissue.
8. Replace the objective in the objective turret, and screw it in to secure it.
9. Repeat these steps to clean the second objective, if necessary.
10. In the Imaging Configuration tab on Reader Setup dialog (which you opened in step 1), click **Auto Calibration** to calibrate the objectives.

When the calibration is finished, the instrument is ready to use.

Tips

- Do not allow the lens to air dry.
- Always use an unused portion of the lens tissue when wiping the lens.
- If smears are still present after performing these steps, repeat the procedure.

Flush/Purge the Fluid Path

Applies only to Cytation 5 models with a dispenser.

At the end of each day that the dispense module is in use, flush the fluid path using the Gen5 priming utility. Leave the fluid to soak overnight or over a weekend, and then purge the fluid before using the instrument again.

This flushing and purging routine is also recommended before disconnecting the outlet tubes from the reader, and before decontamination to remove any assay residue prior to applying isopropyl alcohol or sodium hypochlorite.

To flush the fluid path:

1. Fill two supply bottles with deionized or distilled water. Insert the supply (inlet) tubes into the bottles.
2. Place the priming plate on the carrier.
3. From the Gen5 main screen, select **System > Instrument Control > Cytation 5**.
4. Click the **Prime** tab and select **Dispenser 1**.
5. Set the Volume to **5000 µL**. Keep the default prime rate.
6. Click **Prime** to start the process. When the process is complete, carefully remove the priming plate from the carrier and empty it.
7. Repeat the process for Dispenser 2.

Leave the water in the system overnight or until the instrument will be used again. Purge the fluid from the system (see below) and then prime with the dispense reagent before running an assay.

To purge the fluid from the system:

1. Place the inlet tubes in empty supply bottles or a beaker.
2. Select **System > Instrument Control > Cytation 5**.
3. Click the **Prime** tab and select **Dispenser 1**.
4. Set the Volume to **2000 µL**.
5. Click **Purge** to start the process.
6. When the purge is complete, repeat the process for Dispenser 2.

After purging the system, you may wish to run a quick Dispense protocol to visually verify the dispense accuracy.

Empty/Clean the Tip Priming Trough

Applies only to Cytation 5 models with a dispenser.

The tip priming trough is a removable cup located in the rear pocket of the microplate carrier, used for performing the Tip Prime. The trough holds about 1.5 mL of liquid and must be periodically emptied and cleaned by the user. Gen5 will instruct you to do this at the start of an experiment that requires dispensing.

1. Extend the microplate carrier and carefully remove the tip priming trough from the carrier.

2. Wash the trough in hot, soapy water. Use a small brush to clean in the corners.
3. Rinse the trough thoroughly and allow it to dry completely.
4. Replace the trough in the microplate carrier.

Clean the Priming Plate

Applies only to Cytation 5 models with a dispenser.

Clean the priming plate regularly to prevent bacteria growth and residue buildup. Wash the plate in hot, soapy water, using a small brush to clean in the corners. Rinse thoroughly and allow it to dry completely.

Clean the Dispense Tubes and Injectors

Applies only to Cytation 5 models with a dispenser.

The Cytation 5's dispense tubes and injectors require routine cleaning, at least quarterly and possibly more frequently depending on the type of fluids dispensed.

Required Materials

- Protective gloves
- Safety glasses
- Mild detergent
- Clean, lint-free cotton cloths
- Deionized or distilled water
- Stylus (stored in a plastic cylinder affixed to the rear of the dispense module or reader) (PN 2872304)

Remove the Dispense Tubes and Injector Holders

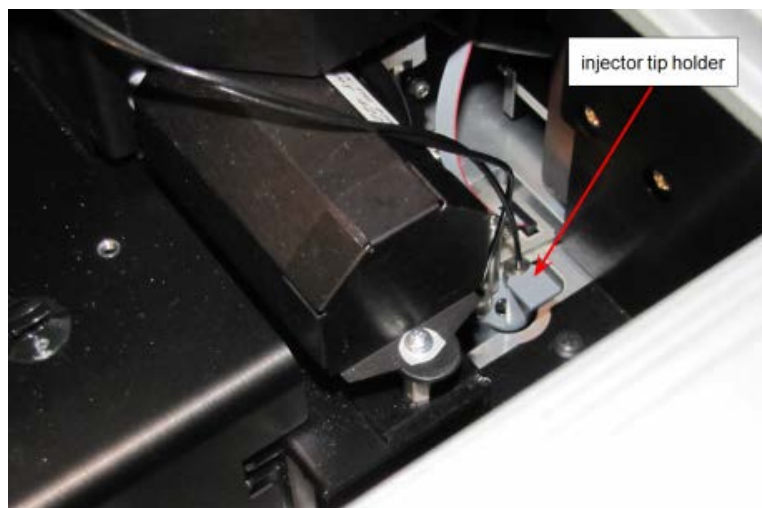

1. Open the door on the front of the reader.
2. Grasp the injector tip holder by the tab and pull it up out of its socket.
3. Using your fingers, remove the thumbscrews securing the light shield to the top of the reader and slide the shield up the outlets tubes.
4. Slide the injector tip holder through the hole in the top of the reader.
5. Turn each tube's thumbscrew counterclockwise and gently pull each tube from its injector tip.
6. On the dispense module, turn each outlet tube's thumbscrew counterclockwise to disconnect it from the injector.

Clean the Dispense Tubes and Injectors

Some reagents can crystallize and clog the tubing and injectors. Daily flushing and purging can help to prevent this, but more rigorous cleaning may be necessary if reagent has dried in the tubing or injectors.

To clean the dispense tubes, soak them in hot, soapy water to soften and dissolve any hardened particles. Flush each tube by holding it vertically under a stream of water.

To clean the injectors:

1. Gently insert the stylus into each injector tip to clear any blockages. (The stylus is stored in a plastic cylinder affixed to the rear of the dispense module.)
2. Stream water through the pipe to be sure it is clean. If the water does not stream out, try soaking in hot, soapy water and then reinserting the stylus.

Be careful not to damage the injector tips. A damaged tip might not dispense accurately.

Instrument Testing

System Test

Each time the Cytation 5 is turned on, it automatically performs a series of tests on the reader's motors, lamp(s), the PMT(s), and various subsystems. If all tests pass, the microplate carrier is ejected and the green LED on the carrier switch remains on.

If any test results do not meet the internally coded Failure Mode Effects Analysis (FMEA) criteria established by BioTek, the reader beeps repeatedly and the red LED on the carrier switch flashes. If this occurs, press the carrier eject button to stop the beeping. If necessary, initiate another system test using Gen5 to try to retrieve an error code from the reader.

1. Turn on the reader and launch Gen5.
2. If your assays use incubation, we recommend enabling Temperature Control and allowing the incubator to reach its set point before running the system test. To access this feature, from the Gen5 main screen, select **System > Instrument Control** and click the **Pre-Heating** tab.
3. Select **System > Diagnostics > Run System Test**.
4. When the test is complete, a dialog appears, requesting additional information. Enter your user name and other information (if desired) and then click **OK**.
5. The results report appears. It shows either "SYSTEM TEST PASS" or "SYSTEM TEST FAIL *** ERROR (error code) DETECTED."
6. Print the report if desired.
7. If the test failed, look up the error code in the *Cytation 5 Operator's Manual* to determine its cause. If the cause is something you can fix, turn off the reader, fix the problem, and then turn the reader back on and retry the test. If the test continues to fail, or if the cause is not something you can fix, contact BioTek's Technical Assistance Center.

Absorbance Plate Test

This test uses BioTek's Absorbance Test Plate (PN 7260522) to confirm mechanical alignment; optical density accuracy, linearity, and repeatability; and wavelength accuracy. The Absorbance Plate Test compares the reader's optical density and wavelength measurements to NIST-traceable values. The Absorbance OD Standards section contains NIST-traceable standard OD values for the filters at several different wavelengths. We recommend testing at six wavelengths – those at or close to the wavelengths used in your assays.

Setup

1. Obtain the certificates that came with the Test Plate.
2. Start Gen5 and from the main screen select **System > Diagnostics > Test Plates > Add/Modify Plates**.

3. Click **Add**. The Absorbance Test Plate dialog appears.
4. Select the appropriate Plate Type and enter the plate's serial number.
5. Enter the Last Certification and Next Certification dates from the calibration sticker on the Test Plate.
6. If the wavelength values in the top row of the grid in Gen5 are appropriate for your tests, enter the OD values from the data sheet into the grid. Make sure you enter the correct value for each well/wavelength combination.
7. Select the number of Peak Wavelength tests to run (up to 4), based on the number of expected peak wavelength values provided on the certificate.
8. Enter the Expected Peak value(s) from the certificate and set the Test Range - and + values.
 - If the C6 filter is Holmium or Erbium glass, the certificate contains two Spectral Band Pass tables. The Cytation 5 has a band pass wider than 5 nm for wavelengths greater than 285 nm and less than 4 nm for 230-285 nm. As a result, we recommend you use the expected peak values in the 5.0 nm table for your tests.
 - For the Erbium glass, any peak can be used.
 - For the Holmium glass, use the expected peak values closest to 242, 279, 362, 417, and 538 nm. For example, if your certificate looks like the one below, you might choose to run the test at four of the five highlighted Expected Peak/Test Range combinations:

2.4 nm Spectral Band Pass		5.0 nm Spectral Band Pass	
Expected Peak	Test Range	Expected Peak	Test Range
241	-5+5	242	-5+5
278	-6+4	279	-6+4
287	-4+6	288	-4+6
334	-5+5	334	-5+5
360	-5+5	362	-5+5
417	-5+5	417	-5+5
484	-5+5	485	-5+5
537	-5+5	538	-5+5
642	-5+5	643	-5+5

- If your C6 filter is Didymium glass, a single peak wavelength value is provided. Enter this value and set the Test Range - and + values so the range displayed in parentheses is 580 to 590, as shown here:

Peak wavelength tests: 1

Expected Peak 586 - Test Range 6 + 4 (580 to 590)

- Review all the values you entered. Click **OK** to save the data.

The information you just entered is available on Gen5 each time the Absorbance Plate Test is performed. It may need to be modified after the annual recertification of your test plate.

Procedure

- From the Gen5 main screen, select **System > Diagnostics > Test Plates > Run**. If prompted, select the desired Test Plate and click **OK**.
- When the Absorbance Test Plate Options dialog appears, select **Perform Peak Wavelength Test** if it is not already selected.
- Highlight the wavelength(s) to be included in this test.

Select only those wavelengths most appropriate for your use of the reader.

- (Optional) Enter any Comments.
- Click **Start Test**.
- Place the Test Plate in the microplate carrier so that well A1 is in the right-rear corner of the carrier.
- Click **OK** to run the test.
- When the test is completed, the results report appears. Scroll through the report; every result should show "PASS".

Imaging Tests

These procedures test the level position of the carrier and the reliability of the Auto Focus feature.

Required Materials

- Imaging qualification plate, PN 1222520
- 10X or lower objective
- DAPI 377/447 cube (PN 1225100)
- Gen5 protocols described beginning on page 61
 - Cytation 5 <x>X_CarrierLevel.prt**
 - Cytation 5 AF_Reliability_<x>X.prt**

Carrier Level Test

This test determines how level the carrier is in relation to the imaging system. This test may be run with any of the following objectives: Meiji 2.5X, Zeiss 2.5X, 4X, or 10X.

1. Place the imaging qualification plate on the carrier with well A1 facing up in the right-rear corner of the carrier.
2. If you have not already done so, create the protocol described on page 61.
3. Create a new experiment in Gen5 using the **<x>X_CarrierLevel.prt** protocol, with <x> representing the lowest-power objective you have available.
4. Click **Plate > Read Plate**, save the experiment, then click **OK**.
5. When prompted by Gen5, rotate the plate 180 degrees in the carrier.
6. When the read is finished, analyze the results as described below.

Analyze the Results

1. Calculate the Mean focus height for each set of ten reads in the "Normal" position in wells A1, A12, H1, and H12.
2. Calculate the Mean focus height for each set of ten reads in the "Turnaround" position in wells A1, A12, H1, and H12.
3. Compare the Mean values for each well in its Normal and Turnaround positions by performing these calculations:
 - a. $-1 * (A1 \text{ Normal Mean} - H12 \text{ Turnaround Mean})$
 - b. $(H12 \text{ Normal Mean} - A1 \text{ Turnaround Mean})$
 - c. $-1 * (A12 \text{ Normal Mean} - H1 \text{ Turnaround Mean})$
 - d. $(H1 \text{ Normal Mean} - A12 \text{ Turnaround Mean})$
4. For A1/H12:
 - Calculate the Mean Delta (μm): $(\text{step a results} + \text{step b result}) / 2$
 - Calculate the Carrier Tilt: $\text{Mean Delta} / 25400 \mu\text{m}$
 - The Carrier Tilt must be less than 0.004" to Pass.
5. For A12/H1:
 - Calculate the Mean Delta (μm): $(\text{step c results} + \text{step d result}) / 2$
 - Calculate the Carrier Tilt: $\text{Mean Delta} / 25400 \mu\text{m}$
 - The Carrier Tilt must be less than 0.004" to Pass.

AutoFocus Test

The AutoFocus test confirms the imaging system's ability to repeatedly focus on a known target.

1. Place the imaging qualification plate on the carrier with well A1 facing up in the right-rear corner of the carrier.

- If you have not already done so, create the protocol described starting on page 61.
- Create a new experiment in Gen5 using the **AF_Reliability_<x>.prt** protocol, with <x> representing the objective you are using for each test.
- Click **Plate > Read Plate**, save the experiment, then click **OK**.
- When the read is finished, analyze the results as described below.

Analyze the Results

- For the set of 100 data points in well F7, calculate the Mean, Slope, and Intercept. (If using Microsoft Excel, use the SLOPE and INTERCEPT functions.)
- For each data point, calculate the Residual:

$$[\text{value}] - ((\text{Slope} * [\text{data point sequence \#}]) + \text{Intercept})$$

Example: $325 - ((0 * 1) + 325.9) = -0.9$ Residual for data point #1
- For each data point, compare the absolute value of the Residual with the objective's Limit (μm) value in the chart below (e.g., 95.4 for 2.5X). If the absolute value of the Residual is greater than the Limit, note "1" for that data point; otherwise, note "0".

Depth of Field						
Objective	Magnification	NA	e (μm)	λ (nm)	DOF (μm)	Limit (μm)
10X	10	0.3	6.45	377	6.3	12.7
4X	4	0.13	6.45	377	34.7	69.4
Zeiss 2.5X	2.74	0.12	6.45	377	45.8	91.6
Meiji 2.5X	2.25	0.07	6.45	377	117.9	235.8

- After conducting this comparison for all 100 data points, add up the notations and divide the sum by 100; this is the Measured Autofocus Failure Rate. The Measured Autofocus Failure Rate must be $\leq 1.0\%$ to Pass.
- In the Gen5 plate matrix, select the **FM Ratio [0:DAPI 377,447]** data set. Refer to the chart below for passing criteria for the value displayed in well F7.

Objective	FM Ratio must be
Meiji 2.5X	> 1.4
Zeiss 2.5X	> 1.4
4X	> 25
10X	> 50

Troubleshooting

If any of the imaging tests fail:

- Ensure the imaging qualification plate is clean. You can use canned air to blow any debris from the surface of the plate.
- Ensure your objectives are clean.
- If your imaging tests still fail after cleaning the imaging qualification plate and the objectives, contact BioTek TAC.

Imaging Protocols

The information in the following tables represents the recommended reading parameters. It is possible that your tests will require modifications to some of these parameters, such as the Plate Type.

The Plate Type setting in each Gen5 protocol should match the plate you are actually using.

Carrier Level Tests

Cytation 5 Meiji 2.5X_CarrierLevel.prt, Cytation 5 Zeiss 2.5X_CarrierLevel.prt, Cytation 5 4X_CarrierLevel.prt, Cytation 5 10X_CarrierLevel.prt

Parameter	Default Setting
Detection Method:	Imaging
Read Type:	Endpoint
Plate Type:	1222520 (imaging qualification plate)
Read Step 1	
Process Mode:	Well Mode
Kinetic Step:	Run Time: 18:00 Interval: 2 seconds Reads: 10
Objective:	Meiji 2.5X/Zeiss 2.5X/4X/10X
Read Wells:	A1, A12, H1, H12
Color Channel:	Bright Field

Parameter	Default Setting
Exposure:	LED: 5 Integration time: 50 Gain: 0
Auto Focus Options:	Focus method: Auto focus with optional scan Minimum focus metric ratio: 3 Scan distance: 600 Scan increment: 30 Minimum focus delta: 8 % of capture exposure for focus: 75 Offset from bottom of well: 0
Vibration Detection Options:	CV Threshold: 0.01 Images to average: 1
Horizontal offset from center of well:	0
Vertical offset from center of well:	0
Single image per well:	Selected
Delay after plate movement:	300 msec
After Read Step 1	
Plate Out, In	"Please rotate the plate 180 degrees"
Read Step 2	
Process Mode:	Well Mode
Kinetic Step:	Run Time: 18:00 Interval: 2 seconds Reads: 10
Objective:	Meiji 2.5X/Zeiss 2.5X/4X/10X
Read Wells:	A1, A12, H1, H12
Color Channel:	Bright Field
Exposure:	LED: 5 Integration time: 50 Gain: 0
Auto Focus Options:	Focus method: Auto focus with optional scan Minimum focus metric ratio: 3 Scan distance: 600 Scan increment: 30 Minimum focus delta: 8 % of capture exposure for focus: 75 Offset from bottom of well: 0

Parameter	Default Setting
Vibration Detection Options:	CV Threshold: 0.01 Images to average: 1
Horizontal offset from center of well:	0
Vertical offset from center of well:	0
Single image per well:	Selected
Delay after plate movement:	300 msec

AutoFocus Reliability Tests

Cytation 5 AF_Reliability_Meiji 2.5X.prt, Cytation 5 AF_Reliability_Zeiss 2.5X.prt

Parameter	Default Setting
Detection Method:	Imaging
Read Type:	Endpoint
Plate Type:	1222520_AF (imaging qualification plate)
Kinetic Step:	Run Time: 19:59, Interval: 12 seconds, Reads: 100
Objective:	Meiji 2.5X/Zeiss 2.5X
Read Wells:	F7
Color Channel:	DAPI 377, 447
Exposure:	Auto
Auto-Focus Options:	Focus method: Auto focus with optional scan Minimum focus metric ratio: 3 Scan distance: 600 Scan increment: 30 Minimum focus delta: 8 % of capture exposure for focus: 75 Offset from bottom of well: -50
Auto-Exposure Options:	Target exposure %: 75 Skip %: 0.1 Integration threshold: 100
Vibration Detection Options:	CV Threshold: 0.01 Images to average: 5
Horizontal offset from center of well:	0
Vertical offset from center of well:	0

Parameter	Default Setting
Single image per well	Enabled
Delay after plate movement:	0 msec

Cytation 5 AF_Reliability_4X.prt

Parameter	Default Setting
Detection Method:	Imaging
Read Type:	Endpoint
Plate Type:	1222520_AF (imaging qualification plate)
Kinetic Step:	Run Time: 19:59, Interval: 12 seconds, Reads: 100
Objective:	4X
Read Wells:	F7
Color Channel:	DAPI 377, 447
Exposure:	Auto
Auto-Focus Options:	Focus method: Auto focus with optional scan Minimum focus metric ratio: 25 Scan distance: 600 Scan increment: 30 Minimum focus delta: 8 % of capture exposure for focus: 75 Offset from bottom of well: -50
Auto-Exposure Options:	Target exposure %: 75 Skip %: 0.1 Integration threshold: 100
Vibration Detection Options:	CV Threshold: 0.01 Images to average: 5
Horizontal offset from center of well:	0
Vertical offset from center of well:	0
Single image per well	Enabled
Delay after plate movement:	0 msec

Cytation 5 AF_Reliability_10X.prt

Parameter	Default Setting
Detection Method:	Imaging
Read Type:	Endpoint

Parameter	Default Setting
Plate Type:	1222520_AF (imaging qualification plate)
Kinetic Step:	Run Time: 19:59, Interval: 12 seconds, Reads: 100
Objective:	10X
Read Wells:	F7
Color Channel:	DAPI 377, 447
Exposure:	Auto
Auto-Focus Options:	Focus method: Auto focus with optional scan Minimum focus metric ratio: 50 Scan distance: 600 Scan increment: 30 Minimum focus delta: 8 % of capture exposure for focus: 75 Offset from bottom of well: -50
Auto-Exposure Options:	Target exposure %: 75 Skip %: 0.1 Integration threshold: 100
Vibration Detection Options:	CV Threshold: 0.01 Images to average: 5
Horizontal offset from center of well:	0
Vertical offset from center of well:	0
Single image per well	Enabled
Delay after plate movement:	0 msec

Absorbance Liquid Test

This test confirms the reader's ability to perform to specification with liquid samples. If the test passes, then the lens placement and optical system cleanliness are proven.

Materials

- New 96-well, clear, flat-bottom microplate (Corning Costar #3590 recommended)
- Stock Solution A or B, which may be formulated by diluting a dye solution available from BioTek (A) or from the ingredients listed below (B).

Solution A

- BioTek QC Check Solution No. 1 (PN 7120779, 25 mL; PN 7120782, 125 mL)
- Deionized water

- 5-mL Class A volumetric pipette
 - 100-mL volumetric flask
1. Pipette a 5-mL aliquot of BioTek QC Check Solution No. 1 into a 100-mL volumetric flask.
 2. Add 95 mL of DI water; cap and shake well. The solution should measure approximately 2.000 OD when using 200 μ L in a flat-bottom microwell.

Solution B

- Deionized water
 - FD&C Yellow No. 5 dye powder (typically 90% pure)
 - Tween 20 (polyoxyethylene (20) sorbitan monolaurate) or BioTek wetting agent (PN 7773002) (a 10% Tween solution)
 - Precision balance with capacity of 100 g minimum and readability of 0.001 g
 - Weigh boat
 - 1-liter volumetric flask
1. Weigh out 0.092 g of FD&C Yellow No. 5 dye powder into a weigh boat.
 2. Rinse the contents into a 1-liter volumetric flask.
 3. Add 0.5 mL of Tween 20, or 5 mL of BioTek's wetting agent.
 4. Fill to 1 liter with DI water; cap and shake well. The solution should measure approximately 2.000 OD when using 200 μ L in a flat-bottom microwell.

Procedure

1. Using freshly prepared stock solution (Solution A or B), prepare a 1:2 dilution using deionized water (one part stock, one part deionized water; the resulting solution is a 1:2 dilution).
2. Pipette 200 μ L of the concentrated solution (A or B) into the first column of wells in the microplate.
3. Pipette 200 μ L of the diluted solution into the second column of wells.
4. Using Gen5, read the plate five times at 405 nm using the Normal read mode, single wavelength, no blanking. Save the data after each read ("Normal plate position").
5. Without delay, rotate the plate 180 degrees so that well A1 is in the H12 position. Read the plate five more times, saving the data after each read ("Turnaround plate position").
6. Print ten sets of raw data, or export them to an Excel spreadsheet.

Analyze the Results

- The plate is read five times in “Normal” position at 405 nm. Calculate the Mean OD and Standard Deviation of those five reads for each well in columns 1 and 2.
- For each well in columns 1 and 2, calculate the Allowed Deviation using the repeatability specification for a 96-well plate: $\pm 1\% \pm 0.005$ OD from 0.000 to 2.000 OD ($\text{Mean} * 0.010 + 0.005$). For each well, its standard deviation should be less than its allowed deviation.
- The plate is read five times in the “Turnaround” position at 405 nm. Calculate the Mean OD of those reads for each well in columns 11 and 12.
- Perform a mathematical comparison of the Mean values for each microwell in its Normal and Turnaround positions (that is, compare A1 to H12, A2 to H11, B1 to G12,... H2 to A11). To pass the test, the differences in the compared mean values must be within the accuracy specification for a 96-well microplate: $\pm 1.0\% \pm 0.010$ OD from 0.000 to 2.000 OD.

Repeatability Specification

$\pm 1\% \pm 0.005$ OD from 0.000 to 2.000 OD

$\pm 3.0\% \pm 0.010$ OD from 2.000 OD to 2.500 OD

Fluorescence Liquid Tests

Required Materials

All Tests:

- Deionized or distilled water
- Various beakers, graduated cylinders, and pipettes
- 95% ethanol (for cleaning clear-bottom plates)
- Aluminum foil
- (Optional, but recommended) 0.45-micron filter
- (Optional) Black polyethylene bag(s) to temporarily store plate(s)
- Gen5 protocols listed below and described on page 77

For the Filter-Based Fluorescence System	
Cytation 5_FI_T_SF.prt	Corners, Sensitivity, and Linearity tests, using the top optics
Cytation 5_FP.prt	Fluorescence Polarization test
Cytation 5_TRF.prt	Time-Resolved Fluorescence test

For the Monochromator-Based Fluorescence System	
Cytation 5_M_FI_T_SF.prt	Corners, Sensitivity, and Linearity tests, using the Top optics
Cytation 5_M_FI_B_SF.prt	Corners, Sensitivity, and Linearity tests, using the Bottom optics

Filter Set Setup

Before using the filter-based fluorescence test protocols, create the applicable filter sets shown below in Gen5 ("Green" is used for sodium fluorescein tests, "Blue" for MUB).

The figure displays four screenshots of the Gen5 software interface for configuring filter sets. Each screenshot shows the 'Filter Set 1' configuration panel with the following details:

- Green:** Filter Set Name: Green; Excitation: Band Pass, 485 nm, 20 nm; Mirror: Dichroic, Top 510 nm, Ex (Min/Max) 440/505 nm, Em (Min/Max) 515/640 nm; Emission: Band Pass, 528 nm, 20 nm.
- Blue:** Filter Set Name: Blue; Excitation: Band Pass, 360 nm, 40 nm; Mirror: Dichroic, Top 400 nm, Ex (Min/Max) 320/390 nm, Em (Min/Max) 410/800 nm; Emission: Band Pass, 460 nm, 40 nm.
- TRF:** Filter Set Name: TRF; Excitation: Band Pass, 360 nm, 40 nm; Mirror: Dichroic, Top 400 nm, Ex (Min/Max) 320/390 nm, Em (Min/Max) 410/800 nm; Emission: Band Pass, 620 nm, 40 nm.
- FP:** Filter Set Name: FP; Excitation: Band Pass, 485 nm, 20 nm; Mirror: Dichroic, Top 510 nm, Ex (Min/Max) 440/505 nm, Em (Min/Max) 515/640 nm; Emission: Band Pass, 528 nm, 20 nm. A checkbox for 'Fluorescence Polarization Cube' is checked.

Corners/Sensitivity/Linearity Tests

- Buffer:
 - NIST-traceable Sodium Borate Reference Standard (pH 9.18) (e.g., Fisher-Scientific 1 L Sodium Borate Mfr. #159532, or equivalent), or
 - Phosphate-Buffered Saline (PBS), pH 7.2–7.6 (e.g., Sigma tablets, Mfr. #P4417, or equivalent) and pH meter or pH indicator strips with pH range 4 to 10
- Sodium Fluorescein Powder (1-mg vial, BioTek PN 98155)

- **If testing both Top and Bottom optics (mono-based fluorescence only):** A new, clean 96-well glass-bottom Greiner SensoPlate (Mfr. #655892); or a clean Hellma Quartz 96-well titration plate (Mfr. #730.009.QG); or equivalent
- **If testing the Top optics only:** A new, clean 96-well solid black microplate, such as Corning Costar #3915, or equivalent
- Excitation filter 485/20 nm installed
- Emission filter 528/20 nm installed
- 510-nm dichroic mirror installed

Fluorescence Polarization (FP) Test

- A new, clean, 96-well solid black microplate, such as Corning Costar #3915. A Greiner SensoPlate can also be used.

The FP Test can be performed in conjunction with the **top** Corners/Sensitivity/Linearity Tests, in the same microplate.

- The recommended test solutions are available from Invitrogen Corporation in their “FP One-Step Reference Kit” (PN P3088) or from BioTek (PN 7160014). This kit includes:
 - (Green) Polarization Reference Buffer, 15 mL
 - Green Low Polarization Reference, 4 mL
 - Green High Polarization Reference, 4 mL

The kit also includes two red polarization solutions; these are not used.

- Excitation filter 485/20 nm installed
- Emission filter 528/20 nm installed
- 510-nm dichroic mirror and polarizers installed

Time-Resolved Fluorescence (TRF) Test

- 15-mL conical-bottom, polypropylene sample tube
- Excitation filter 360/40 nm installed
- Emission filter 620/40 nm installed
- 400-nm dichroic mirror installed
- A new, clean 96-well solid white microplate, such as Corning Costar #3912
- The recommended test solution (FluoSpheres carboxylate-modified microspheres, 0.2 μm europium luminescent, 2 μL) is available from Invitrogen Corporation (PN F20881) or from BioTek (PN 7160011)

Test Solutions

Corners/Sensitivity/Linearity Tests

If using BioTek's sodium fluorescein powder (PN 98155), be sure to hold the vial upright and open it carefully; the material may be concentrated at the top. If a centrifuge is available, spin down the tube before opening.

 When diluting the sodium fluorescein powder in buffer, it takes time for the powder to completely dissolve. Allow the solution to dissolve for five minutes, with intermittent vortexing, before preparing the titration dyes.

Wrap the vial containing the stock solution in foil to prevent exposure to light. Discard unused solution after seven days. Discard any open, unused buffer solution after seven days.

- The Sodium Borate solution does not require further preparation; proceed to step 2. If you are using PBS, prepare the solution:
 - (Optional, but recommended) Using a 0.45-micron filter, filter 200 mL of deionized or distilled water.
 - Follow the manufacturer's instructions on the PBS packaging to create 200 mL, dissolving the necessary amount of PBS into the filtered water.
 - Stir the solution (preferably using a stir table) until the PBS is completely dissolved.
 - Check the pH; it should be between 7.2 and 7.6 at 25°C.
- Prepare the sodium fluorescein stock solution:
 - Add 2.0 mL of the buffer solution to the 1 mg Sodium Fluorescein (SF) vial. This yields a 1.3288 mM stock solution.
 - Ensure that the dye has completely dissolved and is well mixed.
- Carefully prepare the dilutions. Label each with "SF" and the concentration:

Mix This SF Solution:	With Buffer:	To Make:	
0.53 mL of 1.3288 mM stock solution	13.47 mL	50.2 μ M	
110 μ L of 50.2 μ M SF	13.89 mL	400 nM	
3.5 mL of 400 nM SF	10.5 mL	100 nM	
0.46 mL of 100 nM SF	13.54 mL	3.3 nM	<i>Corners Test</i>
4.24 mL of 3.3 nM SF	9.76 mL	1 nM	<i>Sensitivity/Linearity Tests</i>

Fluorescence Polarization (FP) Test

The recommended test solutions are available from Invitrogen Corporation or from BioTek. They do not require additional preparation.

Time-Resolved Fluorescence (TRF) Test

The recommended test solutions are available from Invitrogen Corporation or from BioTek.

- Shake the FluoSpheres container vigorously for 30 seconds prior to pipetting. Alternatively, sonicate or vortex the container.
- Mix 10 μ L of FluoSpheres with 10 mL of deionized water, in a 15 mL conical-bottom, polypropylene sample tube. This yields a 20 nM equivalent suspension.
- Shake the vial vigorously for 30 seconds prior to pipetting. Alternatively, sonicate or vortex the container.
- Mix 10 μ L of 20 nM suspension with 10 mL of deionized water, in a 15 mL conical-bottom, polypropylene sample tube. This yields a 20 pM equivalent suspension.
- Refrigerate any unused portions of the FluoSpheres. The temperature must be between +2°C to +6°C.

The prepared TRF plate can be kept for a maximum of seven days, if covered and stored in the dark between +2°C to +6°C.

Allow the plate to sit at room temperature for approximately 15 minutes prior to use.

Procedure

1. If you have not already done so, create the Gen5 protocols described starting on page 77.
2. If you have not already done so, prepare the solutions for the tests you plan to perform. See **Fluorescence Test Solutions** on page 70.

Refer to the pipette maps, next, for the remaining steps.

3. Perform the Corners/Sensitivity/Linearity tests using the Top optics of the filter-based fluorescence system:
 - Pipette the test solutions into a clean 96-well microplate.
 - Create an experiment based on the **Cytation 5_FI_T_SF.prt** protocol. Read the plate, and then save the experiment.

4. To test Fluorescence Polarization capability:
 - Pipette the solutions for the “FP” test into the same plate as used in step 3.
 - Create an experiment based on the **Cytation 5_FP.prt** protocol. Read the plate, and then save the experiment.

5. Perform the Corners/Sensitivity/Linearity tests for the monochromator-based fluorescence system:
 - Create experiments based on the **Cytation 5_M_FI_T_SF.prt** (for the top optics) and **Cytation 5_M_FI_B_SF.prt** (for the bottom optics)

 - Read the plate and then save the experiment.

6. To test the Time-Resolved Fluorescence capability:
 - Pipette the solutions for the “TRF” test into a new 96-well solid white plate.
 - Create an experiment based on the **Cytation 5_TRF.prt** protocol. Read the plate and then save the experiment.

Pipette Maps

Seal the plates with foil or store them in black polyethylene bags until use. When using a clear-bottom plate, if the base of the plate is touched, clean the entire base with alcohol (95% ethanol) and then wipe with a lint-free cloth. Before placing the plate in the instrument, blow the bottom of the plate with an aerosol duster.

Perform these steps carefully, and refer to the grid on the next page.

For the **Corners** test (light gray wells):

- Pipette 200 μ L of the **3.3 nM SF** solution into wells A1–A3, A10–A12, H1–H3, and H10–H12.
- *If using a Hellma plate:* Pipette 200 μ L of buffer into the wells surrounding the 3.3 nM wells ("CBUF" in the grid).

For the **Sensitivity** test (dark gray wells):

- Pipette 200 μ L of the **1 nM SF** solution into well D7.
- Pipette 200 μ L of the buffer solution into wells C9, D9, and E9.

For the **Linearity** test (wells C1–F5):

- Use a multichannel pipette with just four tips installed.
- Pipette 150 μ L of buffer solution into wells C2–F5. Discard the tips.
- Pipette 150 μ L of the **1 nM SF** solution into wells C1–F1.
- Pipette 150 μ L of the 1 nM SF solution into wells C2–F2. Mix the wells using the pipette. Do not discard the tips.

- Aspirate 150 μ L from wells C2-F2, and dispense into wells C3-F3. Mix the wells using the pipette. Do not discard the tips.
- Aspirate 150 μ L from wells C3-F3, and dispense into wells C4-F4. Mix the wells using the pipette. Do not discard the tips.
- Aspirate 150 μ L from wells C4-F4, and dispense into wells C5-F5. Mix the wells using the pipette. Do not discard the tips.
- Aspirate 150 μ L from wells C5-F5, and discard the tips.

	1	2	3	4	5	6	7	8	9	10	11	12
A	3.3 nM	3.3 nM	3.3 nM	CBUF					CBUF	3.3 nM	3.3 nM	3.3 nM
B	CBUF*	CBUF	CBUF	CBUF					CBUF	CBUF	CBUF	CBUF
C	150 μ L: 1.0 nM	0.5 nM	0.25 nM	0.125 nM	0.0625 nM				BUF			
D	1.0 nM	0.5 nM	0.25 nM	0.125 nM	0.0625 nM		200 μ L: 1.0 nM		BUF			
E	1.0 nM	0.5 nM	0.25 nM	0.125 nM	0.0625 nM				BUF			
F	1.0 nM	0.5 nM	0.25 nM	0.125 nM	0.0625 nM							
G	CBUF	CBUF	CBUF	CBUF					CBUF	CBUF	CBUF	CBUF
H	3.3 nM	3.3 nM	3.3 nM	CBUF					CBUF	3.3 nM	3.3 nM	3.3 nM

*CBUF applies only to the Hellma Quartz plate.

Fluorescence Polarization (FP) Test

- Pipette 200 μ L of the (green) polarization buffer (BUF) into wells A6-H6.
- Pipette 200 μ L of the green high polarization reference (HPR) into wells A7-B7.
- Pipette 200 μ L of the green low polarization reference (LPR) into wells A8-H8.

	1	2	3	4	5	6	7	8	9	10	11	12
A						BUF	HPR	LPR				
B						BUF	HPR	LPR				
C						BUF		LPR				
D						BUF		LPR				
E						BUF		LPR				
F						BUF		LPR				
G						BUF		LPR				
H						BUF		LPR				

Time-Resolved Fluorescence (TRF) Test

- Pipette 200 μL of deionized water into wells A6–C6.
- If you have not already done so, shake the vial of 20 pM europium suspension vigorously for 30 seconds prior to pipetting. Alternatively, sonicate or vortex the vial.
- Pipette 200 μL of the 20 pM europium suspension (Eu) into well A8.

	1	2	3	4	5	6	7	8	9	10	11	12
A						DI		Eu				
B						DI						
C						DI						
D												
E												
F												
G												
H												

Results Analysis

Corners Test

1. Calculate the Mean of the 12 wells containing the 3.3 nM SF test solution (A1–A3, A10–A12, H1–H3, and H10–H12).
2. Calculate the Standard Deviation for the same 12 wells.
3. Calculate the %CV: $(\text{Standard Deviation} / \text{Mean}) * 100$

The %CV must be **< 3.0** to pass.

Sensitivity Test

1. Calculate the Mean and Standard Deviation of the 16 reads for each of the buffer wells (C9, D9, E9).
2. Among the three buffer wells, find the Median Standard Deviation and corresponding Mean.
3. Calculate the Mean for the 16 reads of the SF Concentration well (D7).
4. Calculate the Signal-to-Noise Ratio (SNR) using the Mean SF Concentration, Buffer Median STD with its corresponding Buffer Mean:
 $(\text{SF Mean} - \text{Buffer Mean}) / (3 * \text{Buffer STD})$
5. Calculate the Detection Limit, in pM, using the known concentration value of SF and the Calculated SNR: $1000/\text{SNR}$

Filter-Based Fluorescence System	
Optic Probe	To pass, the Detection Limit must be less than or equal to:
Top	10 pM

Monochromator-Based Fluorescence System	
Optic Probe	To pass, the Detection Limit must be less than or equal to:
EX 485 nm, EM 528 nm	Top/Bottom: 20 pM

Linearity Test

1. Calculate the Mean of the four wells for each concentration in columns 1-5.
2. Perform linear regression using these values as inputs:

Filter- and Monochromator-Based Fluorescence System	
x	y
1000	Mean of the 1000 pM wells
500	Mean of the 500 pM wells
250	Mean of the 250 pM wells
125	Mean of the 125 pM wells
62.5	Mean of the 62.5 pM wells

3. Calculate the R-Square value; it must be ≥ 0.950 to pass.

Fluorescence Polarization (FP) Test

1. Using the raw data from the Parallel read:
 - Calculate the Mean Blank (wells A6-H6).
 - Calculate the Signal for each HPR well: Subtract the Mean Blank from its measurement value.
 - Calculate the Signal for each LPR well: Subtract the Mean Blank from its measurement value.
2. Using the raw data from the Perpendicular read:
 - Calculate the Mean Blank (wells A6-H6)
 - Calculate the Signal for each HPR well: Subtract the Mean Blank from its measurement value.
 - Calculate the Signal for each LPR well: Subtract the Mean Blank from its measurement value.

3. Calculate the G-Factor for each LPR well:

$$\frac{\text{Parallel LPR Sign} * (1-0.02)}{\text{Perpendicular LPR Signal} * (1+0.02)}$$
4. Calculate the Mean G-Factor.
5. Calculate the Polarization value in mP for each HPR well (“PLPR”):

$$\frac{\text{Parallel HPR Signal} - \text{Mean G-Factor} * \text{Perpendicular HPR Signal} * 1000}{\text{Parallel HPR Signal} + \text{Mean G-Factor} * \text{Perpendicular HPR Signal}}$$
6. Calculate the Mean PHPR, in mP.

Optic Probe	To pass, the Mean PHPR must be greater than:
Top, with 510 nm dichroic mirror	340 mP

7. Calculate the Polarization value in mP for each LPR well (“PLPR”):

$$\frac{\text{Parallel LPR Signal} - \text{Mean G-Factor} * \text{Perpendicular LPR Signal} * 1000}{\text{Parallel LPR Signal} + \text{Mean G-Factor} * \text{Perpendicular LPR Signal}}$$
8. Calculate the Standard Deviation of the “PLPR,” in mP.

Optic Probe	To pass, the Standard Deviation of the PLPR must be less than:
Top, with 510 nm dichroic mirror	5 mP

Time-Resolved Fluorescence (TRF) Test

1. Calculate the Mean and Standard Deviation of the 16 reads for each of the buffer wells (A6, B6, C6).
2. Among the three buffer wells, find the Median Standard Deviation and corresponding Mean.
3. Calculate the Mean for the 16 reads of the Eu Concentration well (A8).
4. Calculate the Signal-to-Noise Ratio (SNR) using the Mean Eu Concentration and Buffer Median STD with its corresponding Buffer Mean:

$$\frac{\text{Eu Mean} - \text{Buffer Mean}}{3 * \text{Buffer STD}}$$
5. Calculate the Detection Limit, in fM:

$$20000 / ((\text{Mean Eu} - \text{Mean DI water}) / (3 * \text{Standard Deviation DI water}))$$

Optic Probe	To pass, the Detection Limit must be less than or equal to:
Top, with 400 nm dichroic mirror	250 fM

Troubleshooting

If any tests fail, please try the following suggestions. If the test(s) continue to fail, print the results and contact BioTek’s Technical Assistance Center.

- Are the solutions fresh? Discard the plate and any open, unused test solutions after seven days.
- Are the excitation/emission filters clean? Are they in the proper locations and in the proper orientation in the filter cube?
- If the Corners Test continues to fail, the hardware may be misaligned. Contact BioTek TAC.
- Are you using new/clean plates? If the base of a clear-bottom plate is touched, clean the entire base with alcohol (95% ethanol) and then wipe with a lint-free cloth. Before placing the plate in the instrument, blow the bottom of the plate with an aerosol duster. If the test fails again, the optical probe(s) may need to be cleaned. Contact BioTek's Technical Assistance Center for instructions.
- Review the pipetting instructions to verify the plate was correctly prepared.
- Does the Plate Type setting in the Gen5 protocol match the plate you used?
- For injector models, spilled fluid inside the reader may be fluorescing, which can corrupt your test results. If you suspect this is a problem, contact BioTek TAC.
- When testing Fluorescence Polarization capability using a solid black plastic microplate, if the standard deviation for the buffer wells is too high, try moving the buffer wells to another column. With some black plastic plates, the wells in the center of the plate may be slightly distorted due to the plate molding process, and this can affect the standard deviation.
- The Read steps in the protocols use the Gen5 Automatic Gain Adjustment feature to determine optimum sensitivity values for the plate. If an Auto Gain Result value is outside the range of 50–200, this may indicate a problem.
 - If the value is less than 50:
 - The stock solution/dilution concentrations may be too high. Try creating fresh solutions/dilutions, and rerun the test using a new, clean plate.
 - If all of the tests are passing but the Gain value is low, a PMT in your reader may just be very sensitive. Contact BioTek's Technical Assistance Center to confirm that this may be the case.
 - If the value is greater than 200:
 - The stock solution/dilution concentrations may be too low. Try creating fresh solutions/dilutions, and rerun the test using a new, clean plate.
 - For injector models, spilled fluid inside the reader may be fluorescing, which can corrupt your test results. If you suspect this is a problem, contact BioTek TAC.
 - The PMTs or optical path(s) may be deteriorating, or the optics or other hardware may be misaligned. Contact BioTek's Technical Assistance Center.

Gen5 Protocol Reading Parameters

The information in the following tables represents the recommended reading parameters. It is possible that your tests will require modifications to some of these parameters, such as the Plate Type (see **Troubleshooting Tips** on page 76).

The Plate Type setting in each Gen5 protocol should match the plate you are actually using.

Cytation 5_FI_T_SF.prt

This procedure contains two Read steps using filters to test the top optics: one for the Corners Test and one for the Sensitivity/Linearity Test.

Parameter	Default Setting
Plate Type:	Costar 96 black opaque (#3915)
Read Step 1	
Detection Method:	Fluorescence
Read Type:	Endpoint
Kinetic Loop	Run Time: 00:00:45 Interval: 00:00:03 Reads: 16
Step Label:	"Sensitivity Read"
Read Well:	D7
Filter Set:	1 (Green)
Filters:	EX 485/20 nm, EM 528/20 nm
Optics Position:	Top 510 nm
Gain:	Auto, Scale to High Wells, D7, 30000
Read Speed:	Normal Delay after plate movement: 350 msec Measurements per data point: 50 Lamp Energy: Low Dynamic Range: Standard
Read Height:	7.00 mm
Read Step 2	
Detection Method:	Fluorescence
Read Type:	Endpoint
Kinetic Loop	Run Time: 00:01:35 Interval: 00:00:06 Reads: 16
Step Label:	"Sensitivity Read Buffer"
Read Wells:	C9..E9
Filter Set:	1 (Green)

Parameter	Default Setting
Filters:	EX 485/20 nm, EM 528/20 nm
Optics Position:	Top 510 nm
Gain:	Auto, Use first filter set gain from FIRST Read Step
Read Speed:	Normal Delay after plate movement: 350 msec Measurements per data point: 50 Lamp Energy: Low Dynamic Range: Standard
Read Height:	7.00 mm
Read Step 3	
Detection Method:	Fluorescence
Read Type:	Endpoint
Step Label:	"Corners Read"
Read Wells:	A1..A3, A10..A12, H1..H3, H10..H12
Filter Set:	1 (Green)
Filters:	EX 485/20 nm, EM 528/20 nm
Optics Position:	Top 510 nm
Gain:	Auto, Scale to High Wells, A3, 30000
Read Speed:	Normal Delay after plate movement: 350 msec Measurements per data point: 50 Lamp Energy: Low Dynamic Range: Standard
Read Height:	7.00 mm
Read Step 4	
Detection Method:	Fluorescence
Read Type:	Endpoint
Step Label:	"Linearity Read"
Read Wells:	C1..F5
Filter Set:	1 (Green)
Filters:	EX 485/20 nm, EM 528/20 nm
Optics Position:	Top 510 nm
Gain:	Auto, Scale to High Wells, C1, 30000

Parameter	Default Setting
Read Speed:	Normal Delay after plate movement: 350 msec Measurements per data point: 50 Lamp Energy: Low Dynamic Range: Standard
Read Height:	7.00 mm

Cytation 5_FP.prt

This procedure contains one Read step using filters with Fluorescence Polarization enabled, inside a Plate Mode block.

Parameter	Default Setting
Detection Method:	Fluorescence polarization
Read Type:	Endpoint
Plate Type:	Costar 96 black opaque (#3915)
Shake Step:	Linear for 15 seconds
Delay Step:	5 seconds after shake
Synchronized Mode:	Plate Mode with Timing Control
Read Wells:	A6–H8
Filter Sets:	1 (filter cube)
Filters:	EX 485/20 nm, EM 528/20 nm
Optics Position:	Top 510 nm
Gain:	Auto, Scale to high Wells, A8, 10000
Read Speed:	Normal Delay after plate movement: 350 msec Measurements per data point: 60 Lamp Energy: Low
Read Height:	7.0 mm

Cytation 5_TRF.prt

Parameter	Default Setting
Plate Type:	Costar 96-well white opaque
Delay Step:	3 minutes
Read Step 1	
Detection Method:	Time-resolved fluorescence

Parameter	Default Setting
Read Type:	Endpoint
Kinetic Loop	Run Time: 00:00:15 Interval: 00:00:01 Reads: 16
Step Label:	"Sensitivity Read"
Read Well:	A8
Filter Sets:	1 (filter cube)
Filters:	EX 360/40 nm, 620/40 nm
Optics Position:	Top 400 nm
Gain:	Auto, Scale to High Wells, A8, 30000
Read Speed:	Normal Delay after plate movement: 100 msec Measurements per data point: 50 Lamp Energy: Low
Read Height:	7.00 mm
Read Step 2	
Detection Method:	Time-resolved fluorescence
Read Type:	Endpoint
Kinetic Loop	Run Time: 00:00:45 Interval: 00:00:03 Reads: 16
Step Label:	"Sensitivity Read Buffer"
Read Well:	A6-C6
Filter Sets:	1 (filter cube)
Filters:	EX 360/40 nm, 620/40 nm
Optics Position:	Top 400 nm
Gain:	Auto, Use first filter set gain from FIRST Read Step
Read Speed:	Normal Delay after plate movement: 100 msec Measurements per data point: 50 Lamp Energy: Low
Read Height:	7.00 mm

Cytation 5_M_FI_T_SF.prt and Cytation 5_M_FI_B_SF.prt

Parameter	Default Setting
Plate Type:	Top: Costar 96 black opaque Bottom: Greiner SensoPlate
Read Step 1	
Detection Method:	Fluorescence
Read Type:	Endpoint
Kinetic Loop	Run Time: 00:00:45 Interval: 00:00:3 Reads: 16
Step Label:	"Sensitivity Read"
Read Well:	D7
Wavelength:	1, EX 485/14, EM 528/14 nm
Optics Position:	Top/Bottom
Gain	Auto, Scale to High Wells, D7, 30000
Read Speed:	Normal Delay after plate movement: 100 msec Measurements per data point: 50 Lamp Energy: Low Dynamic Range: Standard
Read Height (for top optics):	7.00 mm
Read Step 2	
Detection Method:	Fluorescence
Read Type:	Endpoint
Kinetic Loop	Run Time: 00:01:35 Interval: 00:00:6 Reads: 16
Step Label:	"Sensitivity Read Buffer"
Read Well:	C9..E9
Wavelength:	1, EX 485/14, EM 528/14 nm
Optics Position:	Top/Bottom
Gain	Auto, Use first filter set gain from FIRST Read Step

Parameter	Default Setting
Read Speed:	Normal Delay after plate movement: 100 msec Measurements per data point: 50 Lamp Energy: Low Dynamic Range: Standard
Read Height (for top optics):	7.00 mm
Read Step 3	
Detection Method:	Fluorescence
Read Type:	Endpoint
Step Label:	"Corners Read"
Read Wells:	A1..A3, A10..A12, H1..H3, H10..H12
Wavelength:	1, EX 485/14, EM 528/14 nm
Optics Position:	Top/Bottom
Gain	Auto, Scale to High Wells, A3, 30000
Read Speed:	Normal Delay after plate movement: 100 msec Measurements per data point: 50 Lamp Energy: Low Dynamic Range: Standard
Read Height (for top optics):	7.00 mm
Read Step 4	
Detection Method:	Fluorescence
Read Type:	Endpoint
Step Label:	"Linearity Read"
Read Wells:	C1..F5
Wavelength:	1, EX 485/14, EM 528/14 nm
Optics Position:	Top/Bottom
Gain	Auto, Scale to High Wells, C1, 30000

Parameter	Default Setting
Read Speed:	Normal Delay after plate movement: 100 msec Measurements per data point: 50 Lamp Energy: Low Dynamic Range: Standard
Read Height (for top optics):	7.00 mm

Luminescence Test

BioTek provides two methods for verifying the performance of luminescence reads. One method measures a Harta Luminometer Reference Microplate, which is an LED-based test plate. Contact BioTek to purchase a plate, or go to www.hartainstruments.com for more information. The other method measures a LUX Biotechnology, Ltd., Glowell unit, which is a small, sealed cylinder with a gaseous tritium light source.

Before using the **Cytation 5 F-LumTest_Harta.prt** or **Cytation 5 F-LumTest_Glowell.prt** protocols described in this section, create the filter set shown below.

Harta Plate Test

Materials

- Harta Luminometer Reference Microplate, PN 8030015
- Harta Plate Adapter, PN 1222205
- Filter cube PN 8040553, LUM Filter Block **or** a filter cube with a plug in EX position 1 or 2 and a hole in the corresponding EM position
- Gen5 protocol described started on page 88

Procedure

1. Turn on the Harta reference plate using the I/O switch on the back of the plate.
2. Check the plate's battery by pressing the test button on the back of the plate and ensuring that the test light turns on.

The test light may be difficult to see in bright light. Change your angle of view or move to a darker environment if you cannot see it.

3. Place the Harta plate adapter on the reader's carrier, then place the test plate on top of the adapter.
4. Create an experiment based on the **Cytation 5 F-LumTest_Harta.prt** or **Cytation 5 M-LumTest_Harta.prt** protocol and read the plate.
5. Calculate and evaluate the results as described on page 86.

Be sure to turn off the Harta plate when you are finished with the test to preserve battery life.

Plate Layout

Cytation 5 F-LumTest_Harta.prt

	1	2	3	4	5	6	7	8	9	10	11	12
A		A2 meas					battery check	battery check				
B												
C												
D	BUF	BUF	BUF	BUF								
E	BUF	BUF	BUF	BUF								
F	BUF	BUF	BUF	BUF								
G	BUF	BUF	BUF	BUF								
H												

Cytation 5 M-LumTest_Harta.prt

	1	2	3	4	5	6	7	8	9	10	11	12
A		A2 meas					battery check	battery check				
B												
C												
D												
E												
F	BUF	BUF	BUF	BUF	BUF	BUF	BUF	BUF	BUF	BUF	BUF	BUF
G	BUF	BUF	BUF	BUF	BUF	BUF	BUF	BUF	BUF	BUF	BUF	BUF
H												

Harta Plate Results Analysis

Through a manual correlation process, it was found that the system requires approximately 35 photons per attomole of ATP, thus a conversion factor of 0.02884 attomole/photon was applied to determine ATP concentration from the NIST data in photons/s.

1. On the Harta plate's Calibration Certificate, locate the NIST measurement for the A2 position and convert it to attomoles:
(A2 NIST measurement * 0.02884)
2. Determine if the plate's battery is still functioning properly:
 - If $A8 > (0.2 * A7)$, the battery is good. Otherwise, it requires replacement.

A replacement battery is included with each Harta plate. A new spare battery will be supplied when the plate is recertified.

3. Calculate the signal-to-noise ratio:
(A2 - Mean of the buffer cells)/(3 * Standard deviation of buffer cells)
4. Calculate the detection limit:
A2 NIST measurement in attomoles/signal-to-noise ratio
 - If the reader is equipped with the low-noise PMT, the detection limit must be ≤ 75 amol to pass.
 - If the reader is equipped with the red-shifted PMT, the detection limit must be ≤ 500 amol to pass.

To determine which PMT is installed, check the label on the back of the reader. #49984 = low-noise PMT; #49721 = red-shifted PMT.

Glowell Test

Materials

- Glowell, PN GLO-466, formerly available from LUX BioTechnology, Ltd. (www.luxbiotech.com)
- Glowell Adapter Plate, available from BioTek, PN 7160006
- Filter cube PN 8040553, LUM Filter Block, **or** a filter cube with a plug in EX position 1 or 2 and a hole in the corresponding EM position.
- Gen5 protocols described starting on page 88

Procedure

1. If you have not already done so, insert the Glowell (“window” side up) into well D8 of the Adapter Plate.
2. Create an experiment based on the **Cytation 5 F-Lum-Test_Glowell.prt** or **Cytation 5 M-LumTest_Glowell.prt** protocol, and read the plate.
3. Calculate and evaluate the results as described on page 87.

Plate Layout

	1	2	3	4	5	6	7	8	9	10	11	12
A									BUF	BUF	BUF	
B									BUF	BUF	BUF	
C									BUF	BUF	BUF	
D								Glowell	BUF	BUF	BUF	
E									BUF	BUF	BUF	
F									BUF	BUF	BUF	
G									BUF	BUF	BUF	
H									BUF	BUF	BUF	

Glowell Results Analysis

1. Locate these items on the Glowell’s Calibration Certificate: Calibration Date, Radiant Flux (pW), Measurement Uncertainty of the Radiant Flux.
2. Calculate the number of days between the Calibration Date and the date the test was performed.
3. Correct the Glowell’s Radiant Flux value for deterioration over time:
Radiant Flux * (1 - 0.000333 * number of days since calibration)
4. Convert the Corrected Radiant Flux value to attomoles:
(Corrected Radiant Flux / 0.021) * 1800

5. Calculate an error factor for the Corrected Radiant Flux (amol):
(Corrected Radiant Flux in amol * Measurement Uncertainty) / 100
6. Calculate the min/max criteria for the Corrected Radiant Flux (amol):
MIN: Corrected Radiant Flux in amol - Error Factor
MAX: Corrected Radiant Flux in amol + Error Factor
7. Calculate the Signal-to-Noise Ratio:
Measurement value of the Glowwell - Mean of Column 9
3 x Standard Deviation of Column 9
8. Calculate the Detection Limit:
Corrected Radiant Flux in amol/Signal-to-Noise Ratio
9. Calculate the min/max criteria for the Detection Limit:
MIN: MIN for Corrected Radiant Flux in amol/Signal-to-Noise Ratio
MAX: MAX for Corrected Radiant Flux in amol/Signal-to-Noise Ratio
 - If the reader is equipped with the low-noise PMT, the detection limit must be **<= 75 amol** to pass.
 - If the reader is equipped with the red-shifted PMT, the detection limit must be **<= 500 amol** to pass.

Gen5 Protocol Reading Parameters

Cytation 5 F-LumTest_Harta.prt

Parameter	Default Setting
Plate Type:	8030015 Harta - w/o 8032028 adapter
Delay Step:	3 minutes
Read Step 1	
Detection Method:	Luminescence
Read Type:	Endpoint
Step Label:	"Reference well A2"
Read Wells:	A2
Filter Sets:	1 (open)
Excitation:	Plug
Emission:	Hole
Gain:	135
Integration Time:	0:10.00 MM:SS.ss
Delay after plate movement:	350 msec
Dynamic Range:	Standard
Read Height:	7.00 mm

Parameter	Default Setting
Read Step 2	
Detection Method:	Luminescence
Read Type:	Endpoint
Step Label:	"Background"
Read Wells:	D1..G4
Filter Sets:	1 (Open)
Excitation:	Plug
Emission:	Hole
Gain:	135
Integration Time:	0:10.00 MM:SS.ss
Delay after plate movement:	350 msec
Dynamic Range:	Standard
Read Height:	7.00 mm
Read Step 3	
Detection Method:	Luminescence
Read Type:	Endpoint
Step Label:	"Battery Check"
Read Wells:	A7-A8
Filter Sets:	1 (Open)
Excitation:	Plug
Emission:	Hole
Gain:	60
Integration Time:	0:01.00 MM:SS.ss
Delay after plate movement:	350 msec
Dynamic Range:	Standard
Read Height:	10.00 mm

Cytation 5 M-LumTest_Harta.prt

Parameter	Default Setting
Plate Type:	8030015 Harta - w/o 8032028 adapter
Delay Step:	3 minutes
Read Step 1	
Detection Method:	Luminescence
Read Type:	Endpoint

Parameter	Default Setting
Step Label:	"Reference well A2"
Read Well:	A2
Wavelength	1
Gain:	150
Integration Time:	0:10.00 MM:SS.ss
Delay after plate movement:	350 msec
Dynamic Range:	Standard
Read Height:	1.00 mm
Read Step 2	
Detection Method:	Luminescence
Read Type:	Endpoint
Step Label:	"Background"
Read Wells:	F1..G12
Wavelength	1
Gain:	150
Integration Time:	0:10.00 MM:SS.ss
Delay after plate movement:	350 msec
Dynamic Range:	Standard
Read Height:	1.00 mm
Read Step 3	
Detection Method:	Luminescence
Read Type:	Endpoint
Step Label:	"Battery Check"
Read Wells:	A7–A8
Wavelength	1
Gain:	80
Integration Time:	0:01.00 MM:SS.ss
Delay after plate movement:	350 msec
Dynamic Range:	Standard
Read Height:	1.00 mm

Cytation 5 F-LumTest_Glowell.prt

Parameter	Default Setting
Plate Type:	Costar 96-well black opaque (#3915)
Delay Step:	3 minutes
Detection Method:	Luminescence
Read Type:	Endpoint
Read Wells:	A8..H11
Filter Sets:	1 (Open)
Excitation:	Plug
Emission:	Hole
Gain:	150
Integration Time:	0:10.00 MM:SS.ss
Delay after plate movement:	350 msec
Dynamic Range:	Standard
Read Height:	7.00 mm

Cytation 5 M-LumTest_Glowell.prt

Parameter	Default Setting
Plate Type:	Costar 96-well black opaque (#3915)
Delay Step:	3 minutes
Detection Method:	Luminescence
Read Type:	Endpoint
Read Wells:	A8..H11
Wavelengths:	1
Gain:	150
Integration Time:	0:10.00 MM:SS.ss
Delay after plate movement:	350 msec
Dynamic Range:	Standard
Read Height:	1.00 mm

Alpha Detection Test

This section applies only to models with the alpha module.

For BioTek Service Personnel only: An alternate method for conducting this test is to follow the Alpha Laser Calibration instructions in the *Cytation 5 Service Manual* (PN 1321023). This calibration requires the use of the EM Mono Efficiency Alpha Jig (PN 7162512 Rev F or higher).

The alpha laser has been factory-calibrated to meet specification. BioTek Instruments, Inc., has developed a test protocol that can be used with Alphascreen Omnibeads to verify the functionality of the alpha laser system. Because the detector for the alpha system is functionally and optically identical to the luminescence system, the luminescence test may be used to verify detector functionality.

The **Crosstalk** test is a measure of how well the optical system can distinguish the signals emitted from the well being read from those of any adjacent well. This test also determines the signal-to-noise ratio (SNR) of the test plate and verifies that the signal is at an acceptable level for the sample material used. The test is designed for use with Alphascreen Omnibeads, and it is assumed that 96-well plates are used with 100 μ L well volumes.

Required Materials

- Recommended test solution, Alphascreen Omnibead Assay kit, available from PerkinElmer (PN 6760626)
- Buffer: Phosphate-Buffered Saline (PBS), pH 7.2–7.6 (e.g., Sigma tablets, Mfg. #P4417 or equivalent)
- Clean 96-well solid white microplate
- 15-mL conical-bottom, polypropylene sample tube
- Alpha filter cube
- Gen5 protocols, described on page 94

Test Solutions

Alphascreen Omnibeads are light sensitive. All tests should be performed under subdued laboratory lighting of less than 100 lux.

1. Prepare the PBS buffer solution:
 - a. (Optional, but recommended) Using a 0.45-micron filter, filter 200 mL of deionized or distilled water.
 - b. Follow the manufacturer's instructions on the PBS packaging to create 200 mL, dissolving the necessary amount of PBS into the filtered water.

- c. Stir the solution (preferably using a stir table) until the PBS is completely dissolved.
 - d. Check the pH; it should be between 7.2 and 7.6 at 25°C.
2. Prepare the Omnibead suspension:
 - a. Shake the container of 5 mg/mL Omnibead suspension vigorously for 30 seconds prior to pipetting. Alternatively, sonicate or vortex the container.
 - b. Mix 20 μ L of 5 mg/mL Omnibead suspension with 4.98 mL of PBS in a 15 mL conical bottom, polypropylene sample tube. This yields a 20 μ g/mL Omnibead suspension.
 - c. Refrigerate any unused portions of the Omnibeads. The temperature must be between +2°C and +6°C.

Pipette Map

	1	2	3	4	5	6	7	8	9	10	11	12
A	BUF	BUF	BUF	BUF	BUF	BUF	BUF	BUF	BUF	BUF	BUF	BUF
B	BUF	20 μ g/mL OMB	BUF	BUF	20 μ g/mL OMB	BUF	BUF	20 μ g/mL OMB	BUF	BUF	20 μ g/mL OMB	BUF
C	BUF	BUF	BUF	BUF	BUF	BUF	BUF	BUF	BUF	BUF	BUF	BUF
D												
E												
F												
G	BUF	BUF	BUF	BUF	BUF	BUF	BUF	BUF	BUF	BUF	BUF	BUF
H	BUF	BUF	BUF	BUF	BUF	BUF	BUF	BUF	BUF	BUF	BUF	BUF

Procedure

Crosstalk Test

1. Pipette 100 μ L of PBS in wells A1–A12, B1, B3–B4, B6–B7, B9–B10, B12, C1–C12, and G1–H12 (see pipette map, “BUF” wells).
2. Pipette 100 μ L of 20 μ g/mL Omnibead suspension into wells B2, B5, B8, and B11 (see pipette map, “20 μ g/mL OMB” wells).

Allow the plate to sit at room temperature for approximately 15 minutes prior to use.

3. Create an experiment based on the **Cytation 5 AlphaTest_Crosstalk.prt** protocol. Read the plate, and then save the experiment.

4. Open the Plate menu and export the data to the embedded Power Export spreadsheet. The spreadsheet reports pass or fail for the test performed. See **Results Analysis**, next, for descriptions of the calculations and troubleshooting tips.
5. Print the spreadsheets and store them with your test records.

Results Analysis

1. Calculate the crosstalk for each of the four wells of Omnibead solution by dividing the background-subtracted Mean value of the surrounding adjacent wells by the background-subtracted Omnibead suspension well.
2. Average the % crosstalk of the four test wells to determine level of crosstalk (Crosstalk Mean).
3. Verify that the % crosstalk is less than or equal to 0.1%
4. Calculate the signal-to-noise ratio (SNR) by using the following equation:

$$\text{SNR} = (\text{signal mean} - \text{background mean}) / (\text{SQRT}(\text{signal STD}^2 + \text{background STD}^2))$$
5. Verify that SNR is greater than or equal to **10**.

Troubleshooting Alpha Tests

If the test fails, please try the following suggestions. If the test(s) continue to fail, print the results and contact BioTek's Technical Assistance Center.

- Are the solutions fresh?
- Have the solutions been stored properly (between +2°C and +6°C)?
- Has the kit been exposed to excessive light (in excess of 100 lux)?
- If the Crosstalk test continues to fail, the laser may not be firing. Contact BioTek TAC.

Gen5 Protocol Reading Parameters

The information in the following table represents the recommended reading parameters. It is possible that your tests will require modifications to some of these parameters, such as Plate Type or Gain value (see **Troubleshooting Tips** above).

The Plate Type setting in the Gen5 protocol should match the plate you are actually using.

Cytation 5 AlphaTest_Crosstalk.prt

Parameter	Default Setting
Plate Type	Costar 96-well white opaque
Detection Method	Alpha
Read Type	Endpoint

Parameter	Default Setting
Read Wells	Full plate
Gain	120
Delay after plate movement	0 msec
Excitation time	100 msec
Delay after excitation	120 msec
Integration time	100 msec
Read height	7.00 mm

Dispense Module Tests

This section applies only to models with the dispenser.

Required Materials

- Absorbance reader with capability of reading at 405, 630, and 750 nm. The reader must have an accuracy specification of $\pm 1.0\% \pm 0.010$ OD or better and a repeatability specification of $\pm 1.0\% \pm 0.005$ OD or better.

The Cytation 5 may be used if it is equipped with absorbance capabilities and has passed the Absorbance Plate Test or Absorbance Liquid Test 1.

- Microplate shaker (if the absorbance reader does not support shaking)
- Precision balance with capacity of 100 g minimum and readability of 0.001 g
- 50–200 μ L hand pipette and disposable tips
- Deionized water
- Supply bottles
- 250-mL beaker
- New 96-well, clear, flat-bottom microplates
- BioTek's Green Test Dye Solution (PN 7773003) undiluted, **or** one of the alternate test solutions listed in the next section
- 100-mL graduated cylinder and 10-mL pipettes (if not using BioTek's Green Test Dye Solution)
- Gen5 software installed on the host PC
- Gen5 protocols described on page 98

Alternate Test Solutions

80 μ L of test solution with 150 μ L of deionized water should read between 1.300 and 1.700 OD at 405/750 nm. The solutions should be at room temperature.

If you do not have BioTek's Green Test Dye Solution (PN 7773003), prepare a dye solution using one of the following methods.

Using BioTek's Blue and Yellow Concentrate Dye Solutions:

Ingredient	Quantity
Concentrate Blue Dye Solution (PN 7773001, 125 mL)	4.0 mL
QC (Yellow) Solution (PN 7120782, 125 mL)	5.0 mL
Deionized water	90.0 mL

Using FD&C Blue and Yellow Dye Powder:

Ingredient	Quantity
FD&C Blue No. 1	0.200 grams
FD&C Yellow No. 5	0.092 grams
Tween 20	1.0 mL
Sodium Azide N_3Na	0.100 gram
Deionized water	Make to 1 liter

Procedure

The *Cytation 5 Operator's Manual* contains the procedure for models without absorbance capabilities.

1. If you have not already done so, create the Gen5 protocols **Cytation 5 Disp 1 Test.prt** and **Cytation 5 Disp 2 Test.prt**, starting on page 98.
2. Prime both dispensers with 4000 μ L of deionized or distilled water.
3. Purge both dispensers with the Volume set to 2000 μ L. This prevents the water from diluting the dye. Remove the inlet tubes from the supply bottles.
4. Fill a beaker with at least 20 mL of the green dye solution. Prime both dispensers with 2000 μ L of the solution. When finished, remove the priming plate from the carrier.
5. In Gen5, create an experiment based on **Cytation 5 Disp 1 Test.prt**.

6. Place a new 96-well microplate on the balance and tare the balance.
7. Place the plate on the microplate carrier.



Running a dispense procedure without placing a plate in the reader will result in contamination of the reader from spilled liquid.

When each dispense step is finished, you will weigh the plate, record the weight, tare the balance with the plate on it, and then place the plate back on the carrier for the next step.

8. Select **Plate > Read** and click **READ**. Gen5 prompts you to empty the tip priming trough.
9. When ready, click **OK** at the Load Plate dialog to begin the experiment. The sequence is as follows:
 - a. Dispense 80 μL /well to columns 1–4.
 - b. Remove the plate and weigh it. Record the weight and tare the balance.
 - c. Place the plate on the carrier and dispense 20 μL /well to columns 5–8.
 - d. Remove the plate and weigh it. Record the weight and tare the balance.
 - e. Place the plate on the carrier and dispense 5 μL /well to columns 9–12.
 - f. Remove the plate and weigh it. Record the weight.
 - g. Manually pipette 150 μL of deionized or distilled water into all 12 columns, on top of the green test dye solution.
 - h. Place the plate on the carrier for a 15-second shake, the “80 μL ” read at 405/750 nm, and the “20 and 5 μL ” read at 630/750 nm.
10. When processing is complete, save the file with an identifying file name.
11. Remove the plate from the carrier and set it aside.
12. Repeat steps 5–11 using **Cytation 5 Disp 2 Test.prt**.
13. See the instructions for analyzing the results below.
14. When all tests are complete, prime both dispensers with at least 5000 μL of deionized water to flush out the green dye solution.

Results Analysis

The pass/fail criteria for each set of 32 wells with the same dispense volume is based on the calculated coefficient of variation (% CV) and Accuracy % Error.

For each volume dispensed (80 μL , 20 μL , 5 μL), for each dispenser (1, 2):

- Calculate the Standard Deviation of the 32 wells
- Calculate the Mean of the 32 wells
- Calculate the %CV: (Standard Deviation / Mean) x 100
- Calculate the Accuracy % Error:

$$\frac{(\text{Actual Weight} - \text{Expected Weight})}{\text{Expected Weight}} * 100$$

Expected Weights for 32 wells: 80 μL (2.560 g), 20 μL (0.640 g), 5 μL (0.160 g). It is assumed that one gram is equal to one milliliter.

Dispense Volume	To pass, %CV must be	To pass, Accuracy % Error must be:
80 μL	$\leq 2.0\%$	$\leq 2.0\%$
20 μL	$\leq 7.0\%$	$\leq 5.0\%$
5 μL	$\leq 10.0\%$	$\leq 20.0\%$

Gen5 Test Protocols for Models with Absorbance Capabilities

Perform the steps in the following sections to create two protocols for testing Dispensers 1 and 2. When finished, save the files as **Cytation 5 Disp 1 (and 2) Test.prt**.

Define the Procedure

The protocol's procedure follows the sequence below. After each dispense step, the plate is ejected to allow the operator to weight it and then tare the balance.

- Dispense 80 μL dye to columns 1–4
- Dispense 20 μL dye to columns 5–8
- Dispense 5 μL dye to columns 9–12
- Shake the plate for 15 seconds
- Read columns 1–4 at 405/750 nm, calculate the Delta OD
- Read columns 5–12 at 630/750 nm, calculate the Delta OD

The detailed procedure is described on the next page. To add a step to the procedure, click the appropriate button on the left side of the Procedure dialog and define the required parameters.

The comments suggested for use with the Plate Out/In steps are optional.

Gen5 Procedure Steps		
#	Step Type	Details
1	Dispense	Dispenser <select 1 or 2, depending on the protocol> Dispense to wells A1..H4 Tip prime before this dispense step, 20 μL Dispense 80 μL at rate 275 $\mu\text{L}/\text{sec}$
2	Plate	Suggested comment: Weigh the plate (80 uL test). RECORD the

Gen5 Procedure Steps		
#	Step Type	Details
	Out,In	weight, TARE the balance. Place the plate back on the carrier. Click OK to continue.
3	Dispense	Dispenser <select 1 or 2, depending on the protocol> Dispense to wells A5..H8 Tip prime before this dispense step, 20 µL Dispense 20 µL at rate 250 µL/sec
4	Plate Out,In	Suggested comment: Weigh the plate (20 uL test). RECORD the weight and TARE the balance. Place the plate back on the carrier. Click OK to continue.
5	Dispense	Dispenser <select 1 or 2, depending on the protocol> Dispense to wells A9..H12 Tip prime before this dispense step, 5 µL Dispense 5 µL at rate 225 µL/sec
6	Plate Out,In	Suggested comment: Weigh the plate (5 uL test). RECORD the weight. PIPETTE 150 uL/well of DI water into all 12 columns. Place the plate back on the carrier. Click OK to perform the Read steps.
7	Shake	Linear at 567 cpm (3 mm) for 15 seconds
8	Read	Step label: "80 ul Read_Dispatch 1" (or _Disp 2) Wells: A1..H4 Detection Method: Absorbance Read Type: Endpoint Read Speed: Normal Two Wavelengths: 405 and 750 nm
9	Read	Step label: "20 and 5 ul Read_Dispatch 1" (or _Disp 2) Wells: A5..H12 Detection Method: Absorbance Read Type: Endpoint Read Speed: Normal Two Wavelengths: 630 and 750 nm

Add Data Reduction Steps

Each Read step is performed using two wavelengths. Create two data reduction steps to calculate the Delta OD values.

1. Select **Protocol > Data Reduction** and select **Custom**.
2. Within this dialog, click **Select Multiple Data Sets** and then click **DS2**.

- Set the **Data In** for DS1 to the 80 μ l Read step at 405 nm.
 - Set the **Data In** for DS2 to the 80 μ l Read step at 750 nm.
3. Click **OK** to return to the dialog.
 4. In the New Data Set Name field, type an identifying name such as 'Delta OD 80 μ l_Disp 1'.
 5. Clear **Use single formula for all wells**.
 6. In the Current Formula field, type **DS1-DS2** and then assign the formula to wells A1 to H4.
 7. Click **OK** to add the transformation to the Data Reduction list.
 8. Create another Transformation similar to the above, with these characteristics:
 - **DS1** set to the 20 and 5 μ L Read step at 630 nm
 - **DS2** set to the 20 and 5 μ L Read step at 750 nm
 - New Data Set Name resembling 'Delta OD 20 and 5 μ l_Disp <#>'
 - Formula DS1-DS2 applied to wells A5 to H12

Specifications

General Specifications

Microplates	
<p>The Cytation 5 accommodates standard 6-, 12-, 24-, 48-, 96-, and 384-well microplates with 128 x 86 mm geometry, 1536-well plates (for imaging only), Take3 and Take3 Trio Micro-Volume Plates, microplate slides, T25 cell culture flasks (with adapter), and 35 mm, 60 mm, and 100 mm Petri dishes (with adapter). Maximum Plate Height: 1.0"</p>	
Hardware and Environmental	
Light Source	
Absorbance, Fluorescence (FI), monochromator-based:	Xenon flash light source, 20W maximum average power (not user-changeable)
Fluorescence (FI/FP), filter-based:	Xenon flash light source, 5W maximum average power (not user-changeable)
TRF (filter-based):	Xenon flash light source, 5W maximum average power (not user-changeable)
Dimensions:	20.25" D x 15.50" W x 17.5" H 51.4 cm D x 39.4 cm W x 44.5 cm H
Weight:	With all modules installed, without power supply or dispense module attached, < 80 lbs. (36.3 kg)
Environment:	Power-up temperature 18°C to 30°C (64.4°F to 86°F) Note: Performance measurements, including detection limits, were verified up to 25°C (77°F).
Humidity:	10% to 85% relative humidity (non-condensing)
Power Supply:	24-volt external power supply compatible with 100–240 V~; +/-10% @50–60 Hz
Power Consumption:	130W maximum
Incubation:	<p>Temperature control ranges from 4°C over ambient to 65°C. Temperature variation \pm 0.5°C across the plate @ 37°C, tested with Innovation Instruments, Inc. temperature test plate Top and bottom incubation controlled via software-adjustable gradient. For models with the alpha laser module: Alpha laser module operation is disabled above an internal instrument temperature of 35°C.</p>

Plate Shaking	<p>Linear:</p> <p>Amplitude: 1 mm to 6 mm in 1-mm steps</p> <p>Frequency*: ~18 Hz to ~6 Hz</p>
	<p>Orbital Slow:</p> <p>Amplitude: 1 mm to 6 mm in 1-mm steps</p> <p>Frequency*: ~10 Hz to ~3 Hz</p>
	<p>Orbital Fast:</p> <p>Amplitude: 1 mm to 6 mm in 1-mm steps</p> <p>Frequency*: ~14 Hz to ~5 Hz</p>
	<p>Double Orbital Slow:</p> <p>Amplitude: 1 mm to 6 mm in 1-mm steps</p> <p>Frequency*: ~10 Hz to ~3 Hz</p>
	<p>Double Orbital Fast:</p> <p>Amplitude: 1 mm to 6 mm in 1-mm steps</p> <p>Frequency*: ~14 Hz to ~5 Hz</p>

* Frequency is based on the amplitude selected.

Dispense/Read Specifications

Maximum Delay between End of Dispense and Beginning of Read 96/384-well plates, default probe heights	
Bottom Mono Fluorescence	T ≤ 0.5 second
Luminescence	T ≤ 0.5 second
Top Filter Fluorescence	T ≤ 1.0 second
Top Mono Fluorescence	T ≤ 1.0 second
Absorbance	T ≤ 1.0 second

Dispense/Read, for models with the dual-reagent dispense module	
Plate Type	Both injectors dispense to standard height 6-, 12-, 24-, 48-, 96-, and 384-well microplates.
Detection Method	Absorbance, Fluorescence (FI, FP, TRF), Luminescence, Imaging (well mode only)
Volume Range	5–1000 µL with a 5–20 µL tip prime
Reagent Dead Volume	< 1100 µL, with dead volume recovery function (back flush)
Injection Speeds	225, 250, 275, 300 µL/second
Accuracy	± 1 µL or 2.0%, whichever is greater
Precision	≤ 2.0% for volumes of 50–200 µL ≤ 4.0% for volumes of 25–49 µL ≤ 7.0% for volumes of 10–24 µL ≤ 10.0% for volumes of 5–9 µL

Absorbance Specifications

Optics	
Wavelength Range	230 to 999 nm
Wavelength Bandpass	< 4 nm (230–285 nm), < 8 nm (> 285 nm)
Measurement Range	0.000 to 4.000 OD
Resolution	0.0001 OD
Increment	1 nm
Wavelength Accuracy	± 2 nm
Wavelength Precision	± 0.2 nm
Minimum kinetic interval (450 nm)	≤ 20 seconds, sweep mode, 96-well microplate

Plate In/Plate Out Speed
≤ 35 seconds, 450 nm, sweep mode, 96-well microplate

Accuracy, Linearity, Repeatability
Specifications apply from 250–999 nm, 200 µL (96-well microplates)
Accuracy (tested with certified neutral density glass)
96-well plate, normal read speed 0–2 OD: +/-1% +/-0.010 OD, delay after plate movement = 100 ms 2–2.5 OD: +/-3% +/-0.010 OD, delay after plate movement = 100 ms
384-well plate, normal read speed 0–2 OD: +/-2% +/-0.010 OD, delay after plate movement = 100 ms 2–2.5 OD: +/-5% +/-0.010 OD, delay after plate movement = 100 ms
96-well and 384-well plate, sweep read speed 0–1 OD: +/-1% +/-0.010 OD

Accuracy, Linearity, Repeatability	
Linearity (by liquid dilution)	
96-well plate, normal read speed	
0–2 OD: +/-1% +/-0.010 OD, delay after plate movement = 100 ms	
2–2.5 OD: +/-3% +/-0.010 OD, delay after plate movement = 100 ms	
384-well plate, normal read speed	
0–2 OD: +/-2% +/-0.010 OD, delay after plate movement = 100 ms	
2–2.5 OD: +/-5% +/-0.010 OD, delay after plate movement = 100 ms	
96-well and 384-well plate, sweep read speed	
0–1 OD: +/-1% +/-0.010 OD	
Repeatability (tested with certified neutral density glass/measured by one standard deviation: 8 measurements per data point)	
96-well and 384-well plate, normal read speed	
0–2 OD: +/-1% +/-0.005 OD, delay after plate movement = 100 ms	
2–2.5 OD: +/-3% +/-0.005 OD, delay after plate movement = 100 ms	
96-well and 384-well plate, sweep read speed	
0–1 OD: +/-2% +/-0.010 OD	
Take3 Plate	
Detection Limit, 260 nm dsDNA	< 5 ng/μL

Fluorescence Specifications (Mono-Based)

The Cytation 5 measures fluorescence with monochromators from the top and bottom of 6- to 384-well plates. All detection limit (DL) requirements are measured by the “two-point” method, which gives the limit of detection at a signal-to-noise ratio of one where noise is defined as three times the standard deviation of the background wells.

Monochromator-Based Fluorescence	
Excitation range	250–700 nm with low-noise PMT 250–900 nm with red-shifted PMT
Emission range	250–700 nm with low-noise PMT 300–700 nm for emission scans with low-noise PMT 250–900 nm with red-shifted PMT 300–900 nm for emission scans with red-shifted PMT
Selectable increment	1 nm
Bandpass	Variable from 9 nm to 50 nm in 1 nm increments (both excitation and emission)
Minimum kinetic interval	< 20 seconds, sweep mode, 96-well microplate

Plate In/Plate Out Speed
≤ 35 seconds, sweep mode, 96-well microplate

Sensitivity
<i>Sodium Fluorescein in phosphate buffered saline (PBS)</i> DL ≤ 20 pM top or bottom read, 5 pM typical Excitation 485 nm, Emission 528 nm
<i>Methylumbelliferone (MUB) in carbonate-bicarbonate buffer (CBB)</i> DL ≤ 0.16 ng/mL (0.91 nM) top read Excitation 360 nm, Emission 460 nm
<i>Propidium Iodide (PI) in PBS</i> DL ≤ 62.5 ng/mL bottom read Excitation 485 nm, Emission 645 nm

Fluorescence Specifications (Filter-Based)

The Cytation 5 measures fluorescence with filters from the top of 6- to 384-well plates.

Plate In/Plate Out Speed

≤ 35 seconds for filter set, sweep mode, 96-well microplate

Fluorescence Intensity

DL ≤ 10 pM (3 pM typical) solution of Sodium Fluorescein in PBS Excitation 485/20, Emission 528/20, 510 nm mirror

DL ≤ 0.16 ng/mL (0.91 nM typical) solution of Methylumbelliferone in CBB, Excitation 360/40, Emission 460/40, 400 nm mirror

Time-Resolved Fluorescence

DL Europium ≤ 250 fM (100 fM typical)

Excitation 360/40 nm, Emission 620/40 nm, 400 nm mirror

Integration time	20 to 2000 μ s
Delay	0 to 2000 μ s
Granularity	1- μ s step

Fluorescence Polarization

5 mP standard deviation at 1 nM Sodium Fluorescein

Excitation 485/20 nm, Emission 528/20 nm, 510 nm mirror

Excitation range: 400 to 700 nm

Emission range: 400 to 700 nm

Luminescence Specifications

The Cytation 5 measures luminescence from the top of 6- to 384-well plates. The following requirements apply to 96-well plates with 200 μ L/well, at room temperature. Production testing is performed using a Harta plate.

Luminescence	
DL	≤ 75 amol/well, 30 amol typical with low-noise PMT ≤ 500 amol/well with red-shifted PMT
Integration Time	10 seconds
Gain	150
Blank Wells	16

Imaging Specifications

The Cytation 5 imaging specifications are based on using an NIH 3T3 plate: 10,000 wells per cell, GFP stain, Costar 3603 black-sided, plastic-bottom plate.

Read Speed	
At 20X, Autofocus on, 96-well plate, 1 image per well	< 10 minutes

